

PEOPLE'S DEMOCRATIC REPUBLIC OF ALGERIA
MINISTRY OF HIGHER EDUCATION AND SCIENTIFIC RESEARCH
MOHAMED BOUDIAF UNIVERSITY OF SCIENCE AND TECHNOLOGY OF ORAN



REPUBLIQUE ALGERIENNE DEMOCRATIQUE ET POPULAIRE
MINISTÈRE DE L'ENSEIGNEMENT SUPÉRIEUR ET DE LA RECHERCHE SCIENTIFIQUE
UNIVERSITÉ DES SCIENCES ET DE LA TECHNOLOGIE D'ORAN MOHAMED
FACULTÉ DE GENIE MECANIQUE



Mechanical engineering department

Course handout

MECHANICAL CONTACTS

Présented by :

Dr MEHALA Kadda

Master 2

Energétique

Installation énergétique et Turbomachine

Academic year 2024-2025

Foreword

The purpose of this course handout is to assess the quality and relevance of the course on contact mechanics (Tribology). This document is an educational resource intended for students or professionals seeking to deepen their knowledge in this field. The evaluation covers the clarity, scientific accuracy, structure, pedagogy and accessibility of the content.

Table contents

1 Contact Mechanical.....	6
2 Tribology.....	6
2.1 General on Tribology.....	6
2.1.1 Definition.....	6
2.1.2 Tribological systems.....	7
2.1.3 The purpose of tribology.....	7
2.1.4 Optimization of the tribological system.....	8
2.1.5 Why is Tribology recent?	8
2.2 Solid contact surface.....	9
2.2.1 Definition	9
2.2.2 Surface structure.....	9
2.2.3 Different layers of material.....	10
2.2.4 Surface topography.....	10
2.2.5 Surface properties.....	11
2.2.5.1 Surface hardness.....	11
2.2.5.2 Surface roughness.....	12
i) Definition and characteristics.....	12
ii) Roughness parameters.....	12
iii) Importance of roughness.....	13
iiii) Classification of surfaces by roughness.....	13
iiiii) Reduction or control of roughnes.....	14
2.2.5.3 Improvement of surface properties.....	15

3. Friction.....	16
3.1 Definition.....	16
3.2 Friction Modes.....	16
3.2.1 Fluid-solid friction.....	16
3.2.1.1 Viscosity	16
3.2.1.2 Flow regimes.....	17
3.1.3 Fluid friction force.....	17
3.1.4 Fluid-solid friction law.....	19
3.1.5 Determination of the flow regime.....	19
3.1.6 Reduction of fluid-solid friction.....	20
3.2 Solid-solid friction.....	20
3.2.1 Types of solid-solid friction.....	20
3.3 Factors influencing solid-solid friction.....	21
3.4 Classical model of friction.....	21
3.5 Applications of solid-solid friction.....	22
3.6 Reduction or increase in friction.....	22
3.7 Friction forces.....	22
3.8 Adhesion contribution of friction.....	23
3.9 Plastic contribution to friction.....	24
3.10 Friction for different types of contact.....	24
3.10.1 Contact between two solids in revolution.....	24
3.10.2 Contact between two cylindrical solids along a direction.....	25
3.10.3 Point contact between solid.....	26
3.11 Constraints and displacements between contacts.....	29
3.11.1 contact with a “linear” loading.....	29
3.11.2 "Point" loading.....	32
3.12 Friction factor and the resulting forces during the displacement of one body relative to another.....	34
3.12.1 Normal Force.....	34
3.12.2 Static and kinetic friction force.....	34

3.12.3 The inclined force applied to the body with respect to the plane.....	35
3.12.4 Friction in an inclined plane	36
3.13 Friction measurement.....	37
4. Wear.....	40
4.1 Adhesive Wear.....	40
4.2 Abrasive Wear.....	40
4.3 Wear phases.....	40
4.4 Wear rate.....	40
5. Hydrodynamic lubrication.....	42
5.1 Definition.....	42
5.2 Lubricated contacts.....	43
5.2.1 The surface contacts.....	43
a) Limit lubrication (Boundary lubrication).....	44
b) Mixed lubrication.....	44
c) Hydrodynamic lubrication.....	45
d) Hydrostatic lubrication.....	45
5.2.2 Hertzian contacts.....	45
a) Extreme pressure lubrication.....	46
b) Mixed lubrication.....	46
c) Elastohydrodynamic lubrication.....	46
5.3 Basic equations of hydrodynamic lubrication.....	47
5.3.1 Reynolds equation.....	47
5.3.2. Energy equation.....	50
5.3.3 The pressure field for two parallel plates.....	51
5.3.4 The pressure field for two non-parallel plates.....	52
Reference	

1. Contact Mechanical

Contact mechanics is a branch of solid mechanics that studies the interactions between two (or more) surfaces when they come into contact. It is essential in many fields such as engineering, tribology and materials modelling. The key concepts of contact mechanics are:

-Contact pressure:

Stress distribution on contacting surfaces.

Classical models: Hertz contact (linear elasticity) for curved surfaces.

-Strain:

Elastic (reversible) and plastic (irreversible) deformations of materials under load.

Effect of material properties: modulus of elasticity, hardness, etc.

-Friction:

Tangential interactions due to sliding or rolling between surfaces.

Coulomb's laws (dry friction) and advanced models (adhesive or lubricated friction).

-Adhesion:

Bonding phenomenon between surfaces caused by capillary, electrostatic or chemical forces.

-Wear :

Loss of material due to prolonged interaction between surfaces, influenced by factors such as load, relative speed and type of contact.

2 Tribology

2.1 General on Tribology [1], [2]

2.1.1 Definition

Tribology comes from the Greek "TRIBEN": study of friction. Tribology is an integral part of the field of machine building.

Tribology is the science that studies the interactions of two surfaces in motion relative to each other. It encompasses the associated technology and all areas of friction and wear, including lubrication. It studies the interactions between contact surfaces, but also those of solids, liquids and gases present between these surfaces. It develops technologies aimed at optimizing friction.

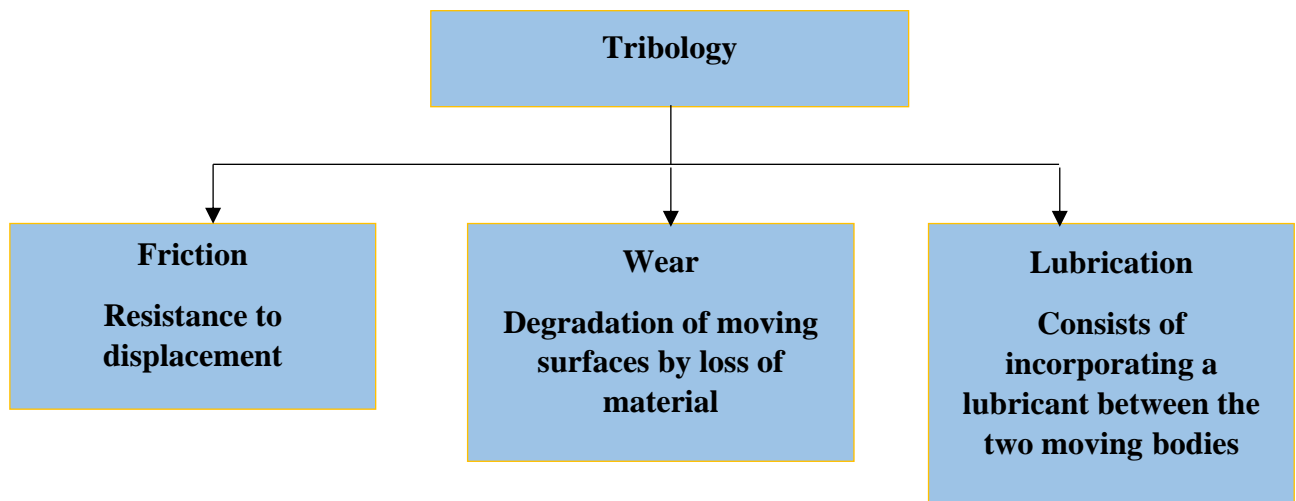

2.1.2 Tribological systems

The applications of tribology can be found wherever there is relative movement between two elements. For example: Plain bearings (between shaft and bearing), Bearings (between the body of the bearing and balls, between balls, tracks and cages), and Gears (between the profiles of the pinions and the toothed wheels). These pairs of elements are found in all machines: engines, transmissions, compressors, hydraulics. We again encounter tribology in metalworking (turning, milling, drilling, etc.), but in this case, it is between workpiece and tool that there will be friction.

2.1.3 The purpose of tribology

Friction is one of the oldest known physical phenomena. It is certainly one of the most important in terms of its technological implications. This is the reason why the concept of tribology was introduced in 1966.

The aim of tribology is to minimize material and energy losses due to wear and friction; it is therefore to succeed in manufacturing efficient mechanical and energy systems. The improvement it brings to moving surfaces (therefore to the tribological system), is to improve the efficiency and lifespan of machines.

The aspects technical and economic improved by tribology are:

- Performance and yield
- Reliability and durability
- Energy and component savings

- Environmental impact

2.1.4 Optimization of the tribological system

This optimization involves three types of adaptations:

1. Decrease in contact: These are the changes that aim to perform movements without any contact. For example: Magnetic rails and slides.

2. Reduction of efforts: These are the measures which without modifying the movements reduce the efforts necessary to carry them out. For example: replacement of a plain bearing by a rolling bearing.

3. Structural changes of the system:

a) By construction choices: From its design, consider the system in its configuration and sizing from a tribological angle.

b) By the choice of lubrication: Application and choice of the appropriate lubricant. For the choice, there are two solutions: either the lubricant separates the moving surfaces, or it intervenes by physical or chemical reactions.

c) By choosing suitable materials: The selection of optimal pairs of materials or the use of optimized surface coatings.

2.1.5 Why is Tribology recent?

The mechanisms have been around for a long time, but the study of tribology is relatively recent for several reasons:

❖Scientific reason:

Tribology has been of little interest to scientists because of the complexity of the material.

❖Technical reason:

- 1) The surface: Calculation of structures to improve strength, have been accomplished for over a century.
- 2) Friction: Friction is a main source of wasted energy.
- 3) Wear: The durability of the parts is limited.
- 4) Unavailability: The cost of spare parts for a turbo alternator group is high.

2.2 Solid contact surface [5]

2.2.1 Definition

A solid contact surface is the interface between a solid and a second medium which can be another solid, a gas (atmosphere) or a liquid.

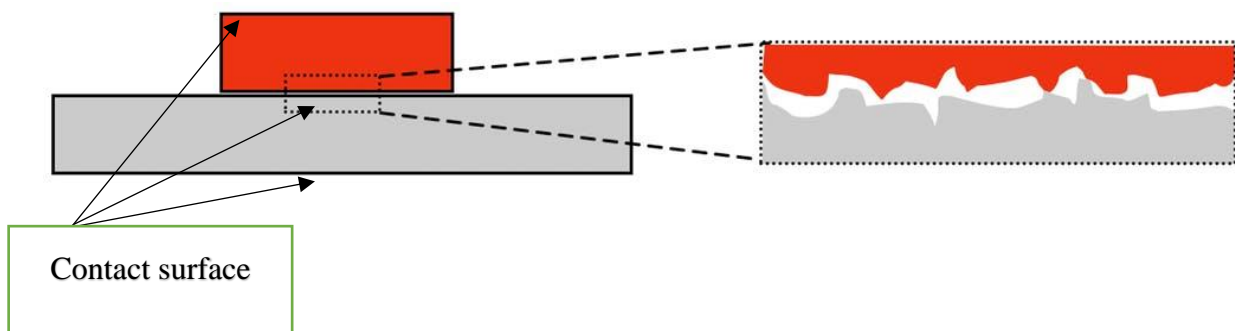

Figure 1. Contact surface

2.2.2 Surface structure

Solids have different physical properties at the surface and at the core of the material. An atom located inside material is in equilibrium under the action of the forces exerted by its neighbour's, the crystallographic aspect of the core atom is presented in Figure 2b.

A surface atom is subjected to the forces of atoms that would be located on the other side of the surface (see Figure 2a).

This results in a reduction in interatomic distances as a result, the mechanical properties of the material are affected on the surface. As well as, surface atoms are likely to interact with the atmosphere.

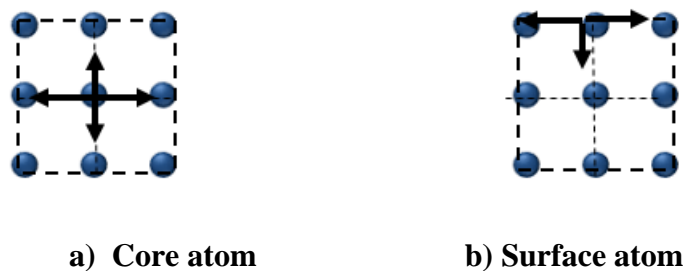

Figure 2. Crystallographic aspect of surfaces

2.2.3 Different layers of material

It is possible to identify different layers (see Figure 3.):

- **Layer of absorbed gas:**

This layer contains molecules of gas, water vapor, oxygen which has been absorbed by the solid, its thickness is from 0.3 to 3nm.

- **Oxide layer:**

Most materials react with oxygen to form an oxide layer; its thickness is 1 to 100nm.

- **Beilby's layer:**

The crystal structure of this layer is different from that of the base material, it is 1 to 100nm thick

- **Deformed Layer:**

This layer is subjected to residual stresses resulting from the manufacturing process, its thickness varies from 1 to 100 μm .

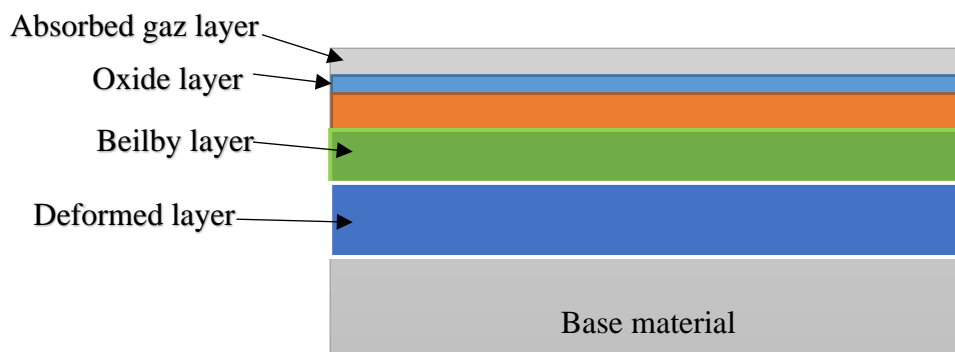

Figure 3. Different layers of the material

2.2.4 Surface topography

The surfaces present geometric deviations from their theoretical shape. Defects can be classified according to their wavelength ' L '. Figure 4 illustrates the surface topography.

- If L is of the order of the size of the surface, it is "Form defect".

- If $0.001 \text{ m} < L < 0.01 \text{ m}$ it is "Ripple fault".

- If the length defect is less, it is "Roughness".

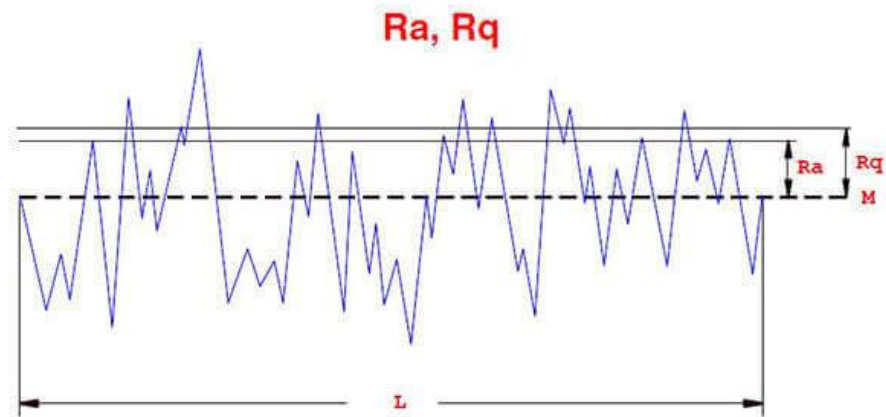

Figure 4. Surface topography

2.2.5 Surface properties

2.2.5.1 Surface hardness

Hardness characterizes the ability of a material (surface) to resist deformation. It is generally measured by applying a force using a punch harder than the material tested so as to leave an imprint on the surface (see Figure 5).

Depending on the shape of the punch, there are different types of hardness:

- Brinell hardness with a ball (HB);
- Vickers hardness with a pyramid (HV);
- Rockwell hardness with a cone (HRC) or ball (HRB);
- Shore hardness (soft material).

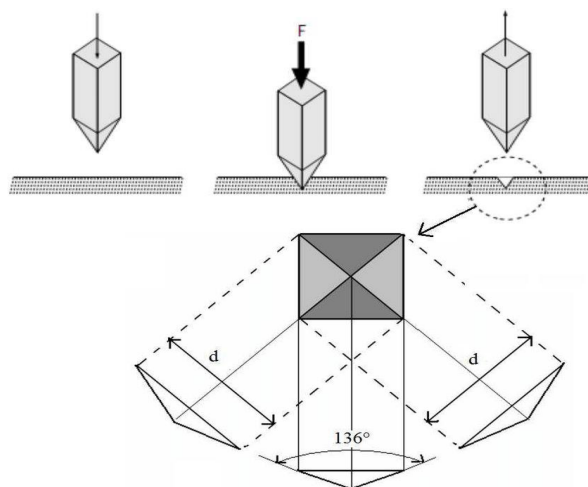

Figure 5. Measuring hardness

2.2.5.2 Surface roughness

Surface roughness refers to microscopic irregularities present on the surface of a material. These asperities, often invisible to the naked eye, directly influence the contact properties between two surfaces, including friction, wear, adhesion and mechanical resistance.

i) Definition and characteristics

Roughness :

- It describes variations in height, depth or shape at the microscopic scale on a surface.
- Roughness is an important component of **surface texture** , which also includes other irregularities such as waviness and overall defects.

Factors influencing roughness :

- **Manufacturing methods** (machining, casting, polishing).
- **Materials used** (ductile, fragile, composite).
- **Surface treatments** (sandblasting, shot blasting, anodizing).

ii) Roughness parameters

Roughness is measured by standardized parameters, usually in micrometers (μm):

- **R_a (Arithmetic Mean Roughness) :**
 - Average of absolute deviations from the mean line of the surface:

$$R_a = \frac{1}{L} \int_0^L |z(x)| dx$$

Or $z(x)$ is the deviation of the surface at a point x , and L is the total length of the measured profile.

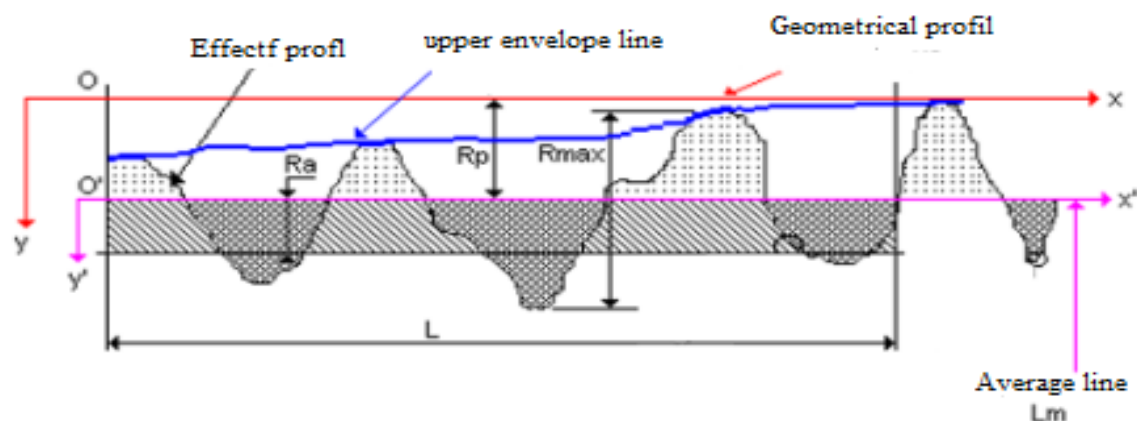

Figure 6. Surface roughness

- **R_q (Root Mean Square Roughness) :**

Root mean square of deviations from the mean line:

$$R_q = \sqrt{\frac{1}{L} \int_0^L z(x)^2 dx}$$

- **R_z (Maximum height of irregularities) :**

Difference between the highest peak and the deepest trough in a section.

- **R_{max} (Maximum profile height) :**

Maximum difference between the highest point and the lowest point over the entire measuring length.

iii) Importance of roughness

1. Friction and adhesion :

- A rough surface increases friction and can aid grip in some cases (eg, tires on wet roads).
- On the other hand, in systems where low friction is desired (bearings, slides), low roughness is preferable.

2. Waterproofing :

- Very rough surfaces can compromise sealing by creating paths for fluids.

3. Wear :

- Rough surfaces generally wear faster due to local stress concentrations.

4. Surface treatments :

- Roughness impacts the effectiveness of coatings and adhesives (eg, paint, glue).

5. Aesthetics and tactile aspect :

- Finished products often have to meet aesthetic or tactile requirements, influenced by roughness.

iiiii) Classification of surfaces by roughness

- **Very smooth surfaces :**

- Polished or precision machined ($R_a < 0.1 \mu\text{m}$).
- Applications: optics, electronics.

- **Moderately rough surfaces :**

- Machined by milling, turning ($R_a \approx 0.1\text{--}1.6 \mu\text{m}$).
- Applications: general mechanics, machine parts.

- **Very rough surfaces :**

- Sabotaged or molded ($R_a > 6.3 \mu\text{m}$).
- Applications: structures, surfaces requiring high adhesion.

iiii) Reduction or control of roughness

1. **Polishing :**
 - Reduces irregularities at the microscopic level.
2. **Heat treatments :**
 - Changes material properties to achieve smoother surfaces.
3. **Coatings :**
 - Addition of a protective or aesthetic layer (paint, anodization).
4. **Optimization of manufacturing processes :**
 - High precision machining, choice of suitable tools.

Table 1. Material hardness

material	HV (MPa)
Carbon steel	55-120
Stainless steel	140
Alumina AL ₂ O ₃	1800
Diamond	10 000

2.2.5.3 Improvement of surface properties

To improve the performance and toughness of the surfaces, attempts are made to modify its hardness, its energy or its resistance to corrosion. There are two techniques:

- **Surface treatment:**

Consists of changing the chemical makeup or crystal structure of the material. For steel, there are several techniques to increase the surface hardness of the material:

- Nitriding: Implantation of nitrogen atoms in steel.
- Carburization: Implantation of carbon atoms in steel.
- Surface or through hardening: Modification of the crystalline structure of steel.

- **Coating:**

Consists of depositing a layer of a different material on the solid, it exists:

- **Hard deposit:** to improve the hardness of the surface.
- **Soft deposit:** to reduce the energy of the surface.

c) Surface energy (γ): This energy comes from atoms on the surface which are free to interact with the environment. The higher this energy, the more easily the surface wears out, the values of γ are low but their impact is not negligible.

Table 2. Surface energy

material	γ (mJ / m ²)
Metals	800 -3000
Ceramic	50 -120
Polymers	10 - 30

3. Friction [3]

3.1 Definition

Mechanical friction is a force, this force decreases the relative movement of two parts in contact (adhesion) and opposes the movement thus leading to a loss of mechanical energy, the surfaces in contact are shown in Figure 7.

- When two bodies move relative to each other, in a viscous medium (air, water, oil), there is resistance to movement (Kinetic Friction Force).

- When pushing an object resting on a horizontal plane, it is necessary to apply a certain force so that the object is put in motion. The sliding of this object on the plane causes a static friction force.

In both cases, the friction comes from the bond between the two surfaces, precisely between the molecules in contact with the two surfaces.

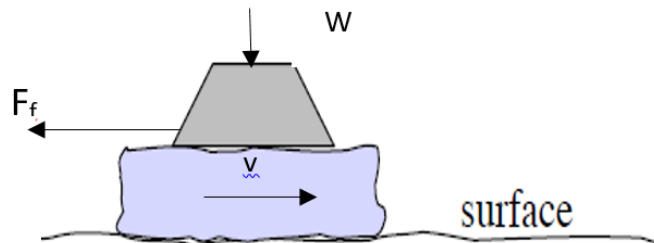

Figure 7. Surfaces in contact

3.2 Friction Modes

Solid friction and **fluid friction** are two distinct mechanisms of resistance to motion that occur under specific conditions.

3.2.1 Fluid-solid friction

Fluid-solid friction, also called **viscous friction**, refers to the resistive forces generated when a fluid (gas or liquid) flows around a solid surface. These forces result from the interaction between the molecules of the fluid and the surface, and they depend on the properties of the fluid and the geometry of the surface. The key concepts are:

3.2.1.1 Viscosity :

- Viscosity (μ) is a fluid property that measures its resistance to flow. It plays a vital role in fluid-solid friction.
- High viscosity fluids (like honey) exert higher friction than low viscosity fluids (like air).

3.2.1.2 Flow regimes :

- a) **Laminar flow** : Layers of fluid slide past each other without mixing . Resistance depends mainly on viscosity.

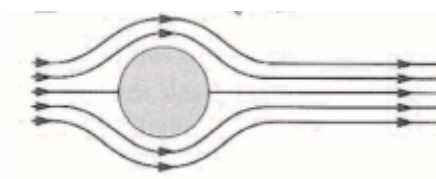

Figure 8a Low velocity flow

- b) **Turbulent flow** : The flow is chaotic, with vortices. Resistance is due to viscosity and inertial forces.

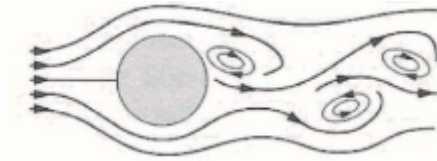

Figure 8b. High speed flow

3.1.3 Fluid friction force

When an object moves in a fluid such as gas or liquid, the molecules of the fluid hit the object, generating a force that opposes the movement. In the absence of motion, there will be no force that generates.

There are several cases , which are crazy depending on the speed of the fluid: a fluid moving around an object

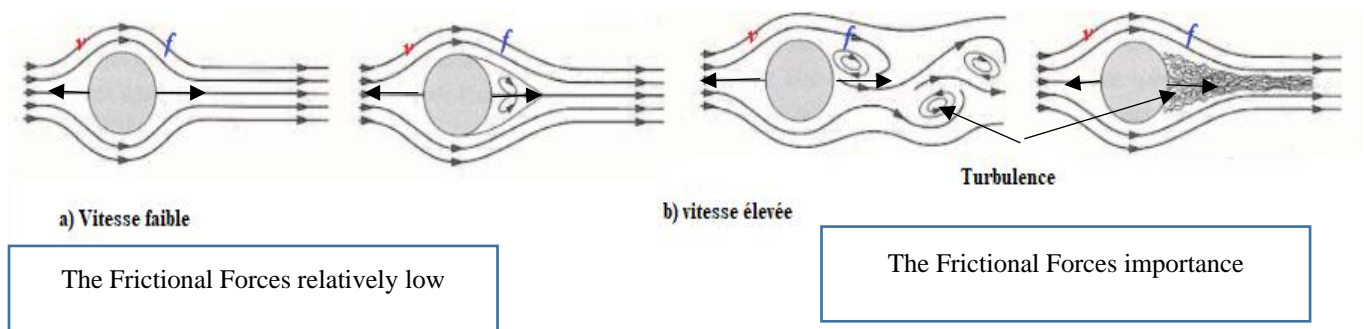

Figure 9. Modeling of forces in flows

a) Low speed (laminar): Viscous friction

The body experiences a force proportional to the speed:

- Direction opposite to speed and given by the following relation:

$$\vec{f} = -k \vec{v} \quad (1)$$

k : coefficient of friction which depends on the object and the fluid and which is measured experimentally.

$$[k] = \frac{[F]}{[v]} = \frac{M L T^{-2}}{L T^{-1}} = M T^{-1} \leftrightarrow [kg S^{-1}] \quad (2)$$

A simpler case, the object is a sphere: we apply the Stokes equation

$$\vec{f} = -6 \pi \eta R \vec{v} \quad (3)$$

R: radius of the sphere

η : dynamic viscosity [$\text{kg.m}^{-1} . \text{s}^{-1}$]

$\eta(\text{water}) = 10^{-3} [\text{kg.m}^{-1} . \text{s}^{-1}]$

$\eta(\text{air}) = 2 . 10^{-5} [\text{kg.m}^{-1} . \text{s}^{-1}]$

- Disappears if speed is zero.

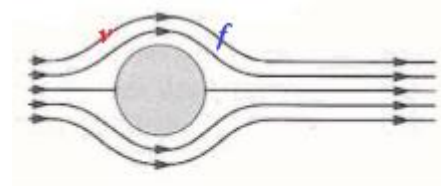

Vitesse faible

b) High speed (turbulent regime)

The body experiences a force proportional to the square of the speed, which has the opposite direction to the speed. The coefficient of friction which is given by:

$$\vec{f} = -\frac{1}{2} C_x \rho_f S v^2 \vec{u} \quad (4)$$

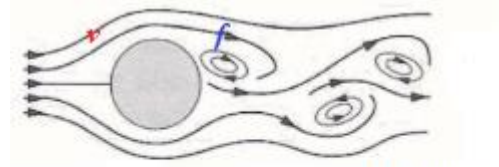

Turbulence
vitesse élevée

C_x : aerodynamic coefficient

ρ_f : density of the fluid

\vec{u} : unit vector

c) Shear and shear stress :

- a. The shear stress at the solid surface is given by:

$$\tau = \mu \frac{\partial u}{\partial y} \quad (5)$$

Or :

τ : shear stress (Pa),

μ : dynamic viscosity (Pa.s),

$\partial u / \partial y$: velocity gradient perpendicular to the surface.

3.1.4 Fluid-solid friction law

- 1. For a flat surface immersed in a fluid :

The fluid friction force (F_f) is proportional to the exposed surface area (A) and to the fluid velocity gradient near the surface.

$$F_f = \tau \cdot A \quad (6)$$

2. For flow around a cylinder or sphere :

Frictional resistance, often called **drag force** , depends on the drag coefficient (C_d)

$$F_d = \frac{1}{2} \rho v^2 C_d A \quad (7)$$

Or :

F_d : drag force,

ρ : density of the fluid,

v : relative fluid velocity,

C_d : drag coefficient (function of geometry and flow regime),

A : projected section perpendicular to the flow.

3.1.5 Determination of the flow regime

The transition from viscous flow to turbulent flow depends on the size and shape of the object and the density of the fluid.

We calculate the Reynolds Number which is expressed by the following formula:

$$Re = \frac{\rho_f L v}{\eta} \quad (8)$$

L : characteristic length of the object
 η depends on the nature of the fluid.

If $Re < 1$ the regime is said to be viscous (Laminar)

If Re is between 10^3 and 10^5 , the regime is said to be turbulent.

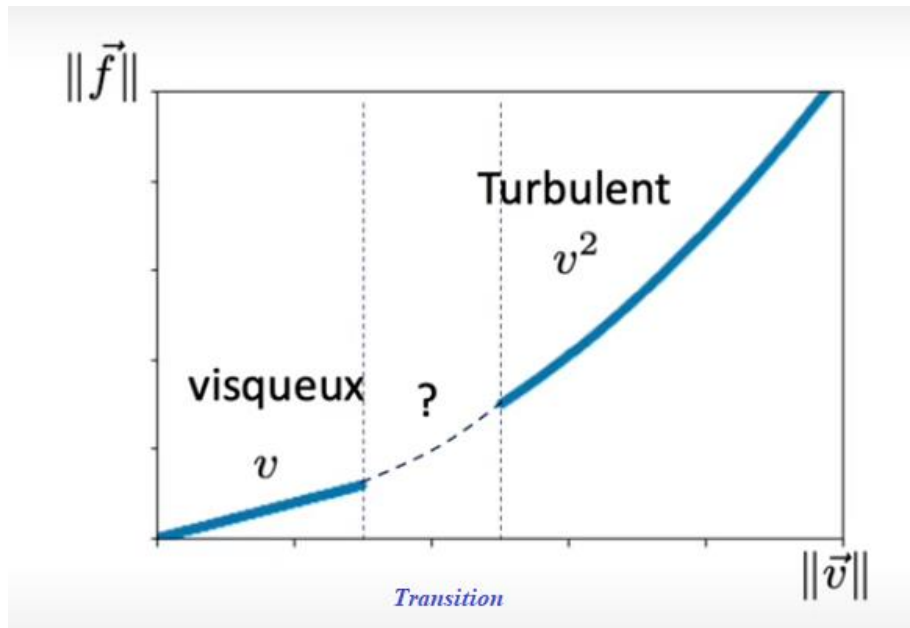
Figure 10. Diagram $\|\vec{f}\| = f\|\vec{v}\|$

3.1.6 Reduction of fluid-solid friction

1. **Geometry optimization :**
 - Reduction of impact surfaces.
 - Use of aerodynamic profiles.
2. **Changing surface properties :**
 - Polishing to reduce roughness.
 - Use of specific coatings.
3. **Flow regime control :**
 - Maintain a laminar diet when possible.

Fluid-solid friction is crucial for the design and optimization of many mechanical and industrial systems involving fluid flows.

3.2 Solid-solid friction

Solid-solid friction refers to the resistance to relative motion between two solid surfaces in contact. This phenomenon plays an important role in mechanics and engineering, influencing the performance of machines, the stability of structures, and the wear of materials.

3.2.2 Types of solid-solid friction

1. **Static friction :**
 - Resistance to the start of relative motion between two surfaces in contact.
 - The maximum force before motion begins is called **the maximum static friction force** :

$$F_{f,\text{statique}} \leq \mu_s \cdot N$$

(9)

Or :

μ_s : coefficient of static friction (unitless),

N : normal force (in N).

2. Dynamic (or kinetic) friction :

- Resistance to motion when surfaces slide past each other.
- The dynamic friction force is given by:

$$F_{f,\text{dynamique}} = \mu_k \cdot N \quad (10)$$

Or :

μ_k : dynamic friction coefficient (usually $\mu_k < \mu_s$).

3.3 Factors influencing solid-solid friction

1. Nature of materials :

- Some materials, such as rubber, have high coefficients of friction, while others, such as polished metals, have lower ones.

2. Surface roughness :

- Rough surfaces increase friction, but excessive roughness can reduce grip by decreasing effective contact.

3. Normal force :

- Friction is directly proportional to the normal force acting between the two surfaces.

4. Lubrication :

- Lubricants (oil, grease, etc.) reduce friction by forming a thin film that separates surfaces.

5. Relative speed :

- At high speeds, friction can vary due to thermal phenomena or changes in surface properties.

3.4 Classical model of friction

In the Coulomb model:

1. The friction force does not depend on the actual contact area.
2. The friction force is proportional to the normal force:

$$F_f = \mu \cdot N \quad (11)$$

3.5 Applications of solid-solid friction

1. **Brakes and clutches :**
 - Use of friction to transmit or dissipate energy.
2. **Machine design :**
 - Reducing wear and optimizing performance through material selection and use of lubricants.
3. **Construction and structures :**
 - Stability of buildings and structures (eg, friction between stone blocks).
4. **Transportation :**
 - Traction between the tires and the road.

3.6 Reduction or increase in friction

Discount:

1. Lubrication (oils, greases).
2. Polishing surfaces.
3. Use of ball or roller bearings to minimize sliding friction.

Increase :

1. Use of adhesive materials (rubber).
2. Creation of rough surfaces (shot blasting, grooving).
3. Increased normal strength.

Solid-solid friction is a ubiquitous phenomenon with practical implications in many fields, from fundamental physics to industrial engineering.

3.7 Friction forces

The friction factor is defined by the following relation:

$$f = \left| \frac{F_f}{W} \right| \quad (12)$$

- When $v \neq 0$, we speak of dynamic or kinetic friction

$$F_f = f \cdot |W| \quad (13)$$

- When $v = 0$, we speak of static friction

$$F_f < f \cdot |W| \quad (14)$$

During friction, a power is dissipated:

$$P = F_f \cdot v = f \cdot W \cdot v \quad (15)$$

The dynamic friction force (F_f) can be a resultant of adhesive forces (F_a) and deformation force (F_d) therefore:

$$Ff = Fa + Fd = (fa + fd).W \quad (16)$$

f_a : coefficient of adhesive friction

f_d : coefficient of friction of plastic deformation

3.8 Adhesion contribution of friction

In the area where the solids are in contact, adhesion forces due to atomic interaction develop. To reinforce these connections, a shear stress (τ_a) is necessary. The force which allows these bonds to be re-established is the adhesion force which is given by:

$$Fa = \tau_a \cdot A \quad (17)$$

A : Total contact area (section)

The adhesive friction factor is given by the following relation:

$$fa = \frac{Fa}{W} = \frac{\tau_a \cdot A}{W} \quad (18)$$

For a superficial elastic contact, the friction factor is given by:

$$fa = \tau_a \frac{2}{E} \sqrt{\frac{2\pi R}{\sigma}} \quad (19)$$

E : modulus of material elasticity

σ : the standard deviation between the two surfaces

R : curvature radius

If the asperity is deformed in a plastic way, the normal force ratio and the contact surface are equal to the duration (H) of a material therefore the friction factor is expressed by:

$$fa = \frac{\tau_a}{H} \quad (20)$$

For an elastic contact, the adhesion friction factor is given by the following relation:

$$fa = \frac{\tau_a \sqrt{2\pi}}{\psi H} \quad (21)$$

ψ : flatness index which is less than 1

3.9 Plastic contribution to friction

Cases of a stiff material with a rough surface slide over a soft material with a smooth surface. The roughness of the hard surface will leave furrows on the mole surface. The presentation of the contact area between two solids is illustrated in Figure 11.

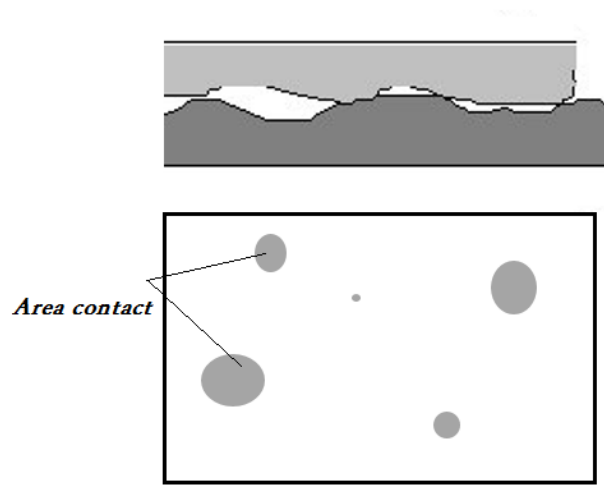

Figure 11. Contact area between two solids

3.10 Friction for different types of contact [4]

3.10.1 Contact between two solids in revolution

The contact between both revolution solids is presented in Figure 12.

* Contact area

$$a = \left(\frac{3.P.R}{4.E^*} \right)^{1/3} \quad m^2 \quad (22)$$

* Normal approximation of the two solids

$$\sigma = \left(\frac{9.P^2}{16.R.E^{*2}} \right)^{1/3} \quad m \quad (23)$$

* Maximum pressure under contact

$$P_0 = \left(\frac{6.P.E^{*2}}{\pi^3.R^2} \right)^{1/3} \quad Pa \quad (24)$$

With:

R: curvature radius (m)

$$\frac{1}{R} = \frac{1}{R_1} + \frac{1}{R_2} \quad (27)$$

$$\frac{1}{E^*} = \frac{1-\nu_1^2}{E_1} + \frac{1-\nu_2^2}{E_2} \quad (26)$$

ν_1 and ν_2 : Poisson ratio of the body 1 and 2

E_1 and E_2 : Young's moduls of the body 1 and 2

* Shear stress under contact

$$\tau_s = 0,31 \cdot P_0 \quad Pa \quad (27)$$

*coefficient of friction

- elastic contact

$$fa = \tau_s \cdot \frac{1}{E} \sqrt{\frac{2 \cdot \pi \cdot R}{\sigma}} \quad (28)$$

- plastic contact

$$fa = \frac{\sigma_s}{H} \quad (28)$$

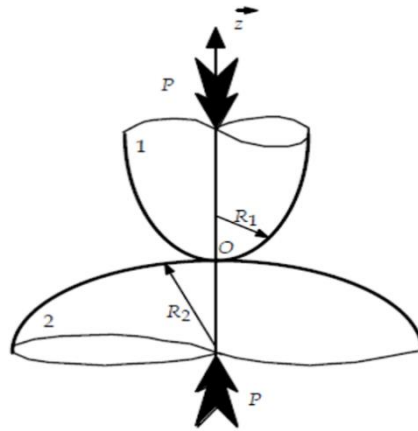

Figure 12. Contact between two bodies of revolution

3.10.2 Contact between two cylindrical solids along a direction

The contact along a direction between two cylindrical solids is shown in Figure 13.

* Contact area

$$a = \frac{4 \cdot R \cdot P}{\pi \cdot L \cdot E^*} \quad m^2 \quad (29)$$

L : Length of the cylindrical contact in (m)

* Maximum pressure under contact

$$P_0 = \left(\frac{P \cdot E^*}{\pi \cdot L \cdot R} \right)^{1/2} \quad Pa \quad (30)$$

* Maximum shear stress under contact $0.3 P_0$ to $0.78 a$

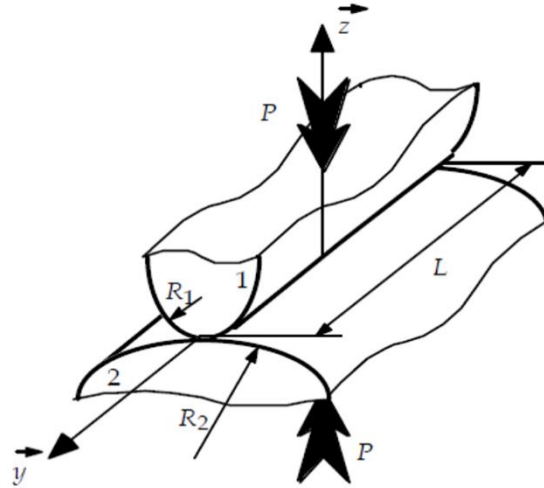

Figure 13. Contact between two cylindrical solids along a direction

3.10.3 Point contact between solid

The point contact between solid is shown in Figure 14.

* Half-axes of the contact ellipse

$$a = e_a \left(\frac{11550 \cdot P}{E^* \cdot \Sigma \rho} \right)^{1/3} \quad (31)$$

$$b = e_b \left(\frac{11550 \cdot P}{E^* \cdot \Sigma \rho} \right)^{1/3} \quad (32)$$

With:

e_a and e_b : coefficient according to the principal curvatures of solids at the points of contact

$$\Sigma \rho = \rho'_1 + \rho''_1 + \rho'_2 + \rho''_2 \quad (33)$$

ρ'_1, ρ''_1 et ρ'_2, ρ''_2 : the principal curvatures of solids at the points of contact

$$F(\rho) = \frac{f(\rho)}{\Sigma \rho} \quad (34)$$

$$f(\rho) = ((\rho'_1 - \rho''_1)^2 + (\rho'_2 - \rho''_2)^2 + 2(\rho'_1 - \rho''_1)(\rho'_2 - \rho''_2) \cos(2\alpha))^{1/2}$$

* Reconciliation of the two solids:

$$\sigma = e_\delta \left(P^2 \Sigma \rho \left(\frac{11550}{E^*} \right)^2 \right)^{1/3} \quad (\text{m}) \quad (35)$$

* Maximum pressure under contact

$$P_0 = \frac{3 \cdot P}{2 \cdot \pi \cdot a \cdot b} \quad (Pa) \quad (36)$$

* Maximum shear stress under contact

$$\tau_s = 0,3 \cdot P_0 \quad Pa \quad (37)$$

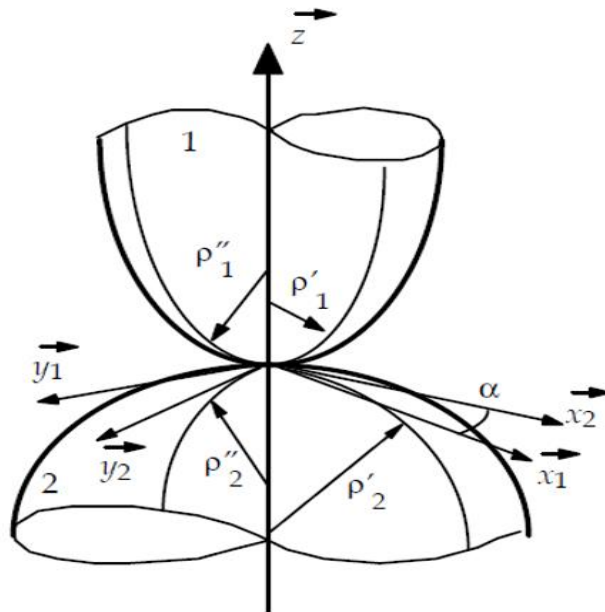

Figure 14. Point contact

Table 3. Values of the coefficient according to the principal curvatures of solids at the points of contact

$F(\rho)$	e_a	e_b	e_δ	$F(\rho)$	e_a	e_b	e_δ
0.0000	0.0507	0.0507	0.00128	0.8270	0.124	0.0266	0.000985
0.0466	0.0523	0.0491	0.00128	0.8310	0.125	0.0264	0.000980
0.1075	0.0545	0.0472	0.00128	0.8350	0.126	0.0263	0.000975
0.1973	0.0582	0.0445	0.00127	0.8389	0.128	0.0261	0.000970
0.2545	0.0607	0.0429	0.00126	0.8428	0.129	0.0260	0.000965
0.3204	0.0639	0.0411	0.00125	0.8468	0.130	0.0258	0.000960
0.3954	0.0681	0.0391	0.00124	0.8507	0.132	0.0256	0.000955
0.4795	0.0738	0.0369	0.00121	0.8545	0.133	0.0255	0.000949
0.5342	0.0780	0.0354	0.00119	0.8584	0.135	0.0253	0.000943
0.5721	0.0814	0.0344	0.00117	0.8623	0.137	0.0251	0.000938
0.6113	0.0853	0.0333	0.00116	0.8661	0.138	0.0250	0.000932
0.6521	0.0899	0.0322	0.00113	0.8699	0.140	0.0248	0.000926
0.6716	0.0925	0.0316	0.00112	0.8737	0.142	0.0246	0.000920
0.6920	0.0953	0.0310	0.00111	0.8774	0.144	0.0245	0.000914
0.7126	0.0984	0.0304	0.00109	0.8811	0.146	0.0243	0.000907
0.7332	0.102	0.0298	0.00108	0.8849	0.148	0.0241	0.000901
0.7538	0.106	0.0291	0.00106	0.8885	0.150	0.0239	0.000894
0.7579	0.107	0.0290	0.00106	0.8922	0.152	0.0237	0.000888
0.7620	0.107	0.0289	0.00105	0.8958	0.154	0.0236	0.000881
0.7661	0.108	0.0287	0.00105	0.8994	0.156	0.0234	0.000874
0.7702	0.109	0.0286	0.00105	0.9030	0.159	0.0232	0.000866
0.7743	0.110	0.0285	0.00104	0.9065	0.161	0.0230	0.000859
0.7784	0.111	0.0283	0.00104	0.9100	0.164	0.0228	0.000851
0.7825	0.112	0.0282	0.00103	0.9134	0.166	0.0225	0.000844
0.7866	0.113	0.0280	0.00103	0.9269	0.179	0.0218	0.000811
0.7907	0.114	0.0279	0.00103	0.9428	0.198	0.0206	0.000765
0.7948	0.115	0.0278	0.00102	0.9458	0.202	0.0204	0.000755
0.7988	0.116	0.0276	0.00102	0.9488	0.207	0.0202	0.000745
0.8029	0.117	0.0275	0.00101	0.9517	0.212	0.0199	0.000734
0.8069	0.118	0.0273	0.00101	0.9574	0.223	0.0194	0.000712
0.8110	0.119	0.0272	0.00100	0.9705	0.258	0.0180	0.000650
0.8150	0.120	0.0270	0.00100	0.9818	0.312	0.0163	0.000575
0.8190	0.121	0.0269	0.000995	0.9909	0.408	0.0143	0.000481
0.8230	0.123	0.0267	0.000990	0.9973	0.648	0.0113	0.000347
0.8270	0.124	0.0266	0.000985	1.0000	∞	0.0000	0.000000

3.11 Constraints and displacements between contacts

The components of stresses and displacements are expressed either in Cartesian coordinates, or in cylindrical coordinates according to the most suitable case. In these different bases, the components will be noted:

$$\text{In (O, x, y, z) axe } \sigma = \begin{bmatrix} \sigma_{xx} & \sigma_{xy} & \sigma_{xz} \\ \sigma_{yx} & \sigma_{yy} & \sigma_{yz} \\ \sigma_{zx} & \sigma_{zy} & \sigma_{zz} \end{bmatrix} \quad (38)$$

$$\text{In (O, r, } \theta, z) \text{ axe } \sigma = \begin{bmatrix} \sigma_{rr} & \sigma_{r\theta} & \sigma_{rz} \\ \sigma_{\theta r} & \sigma_{\theta\theta} & \sigma_{\theta z} \\ \sigma_{zr} & \sigma_{z\theta} & \sigma_{zz} \end{bmatrix} \quad (39)$$

Displacement vector:

In (O, x, y, z) axe

$$\vec{U} = \begin{bmatrix} U_x \\ U_y \\ U_z \end{bmatrix} \quad (40)$$

In (O, r, θ , z) axe

$$\vec{U} = \begin{bmatrix} U_r \\ U_\theta \\ U_z \end{bmatrix} \quad (41)$$

$\sigma_1, \sigma_2, \sigma_3$: The principal stresses

3.11.1 contact with a “linear” loading

a) Concentrated pressure - Flamant problem (1892)

The contact with a linear loading in the form of tangential force, is illustrated in Figure 15.

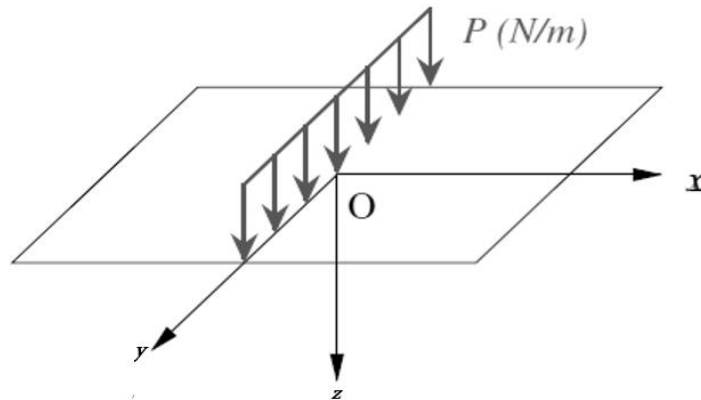

Figure 15. Line loading

P : normal linear force (N/m)

$$\sigma_{rr} = -\frac{2 P \cos\theta}{\pi r} \quad (42)$$

$$\sigma_{\theta\theta} = \sigma_{r\theta} = 0 \quad (43)$$

On the surface : $\theta = \pi/2$

$$U_r = - \frac{(1 - 2\nu)(1 + \nu)}{2E} P \quad (45)$$

$$U_r = - \frac{1-\nu^2}{\pi E} 2P \ln \frac{r_0}{r} \quad r_0 = \text{constant} \quad (46)$$

a) Contact with a tangential linear force

The contact with a linear loading in the form of tangential force is illustrated in Figure 16.

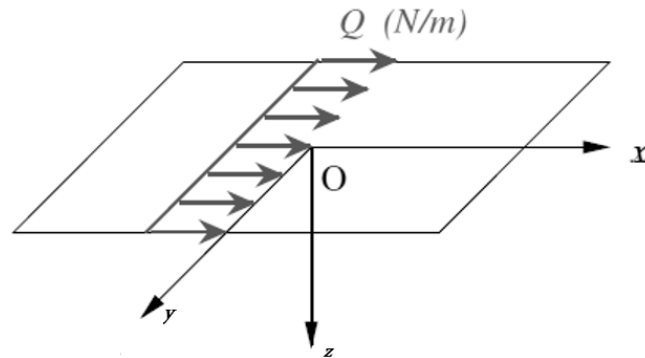

Figure 16. Tangential linear force

$$\sigma_{rr} = - \frac{2Q \sin\theta}{\pi r} \quad (47)$$

$$\sigma_{\theta\theta} = \sigma_{r\theta} = 0 \quad (48)$$

Q : tangential linear force (N/m)

On the surface : $\theta = \pi/2$

$$U_\theta = - \frac{(1-2\nu)(1+\nu)}{2E} Q \quad (49)$$

$$U_r = - \frac{1-\nu^2}{\pi E} 2Q \ln r + U_0 \quad (50)$$

$U_0 = \text{constant}$

b) Contact with a uniform pressure distribution

The contact with a uniform pressure distribution is illustrated in Figure 17.

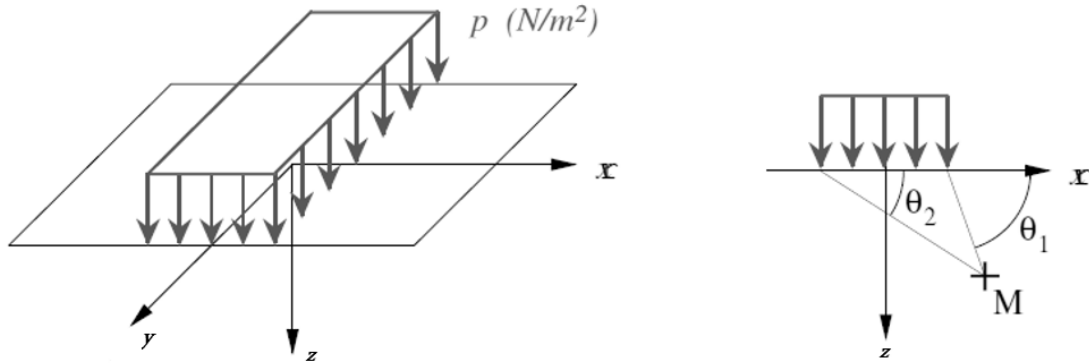

Figure 17. Uniform pressure distribution

P : pressure in N/m^2 ; $\alpha = \theta_1 - \theta_2$

$$\sigma_{xx} = -\frac{p}{2\pi} [2\alpha - (\sin 2\theta_1 - \sin 2\theta_2)] \quad (51)$$

$$\sigma_{zz} = -\frac{p}{2\pi} [2\alpha + (\sin 2\theta_1 - \sin 2\theta_2)] \quad (52)$$

$$\sigma_{xz} = -\frac{p}{2\pi} [(\cos 2\theta_1 - \cos 2\theta_2)] \quad (53)$$

$$\sigma_1 = -\frac{p}{\pi} [(\alpha - \sin \alpha)] \quad (54)$$

$$\sigma_2 = -\frac{p}{\pi} [(\alpha + \sin \alpha)] \quad (55)$$

On the loaded one ($-\alpha \leq x \leq \alpha$)

$$U_x = -\frac{(1-2\nu)(1+\nu)}{E} px \quad (56)$$

$$U_z = -\frac{1-\nu^2}{\pi E} p \left[(a+x) \ln \left(\frac{a+x}{a} \right)^2 + (a-x) \ln \left(\frac{a-x}{a} \right)^2 \right] + U_0 \quad (57)$$

$U_0 = \text{constant}$

3.11.2 "Point" loading

a) Normal concentrated effort - Problem of Boussinesq (1885), Cerruti (1882)

The concentrated normal effort is shown in Figure 18.

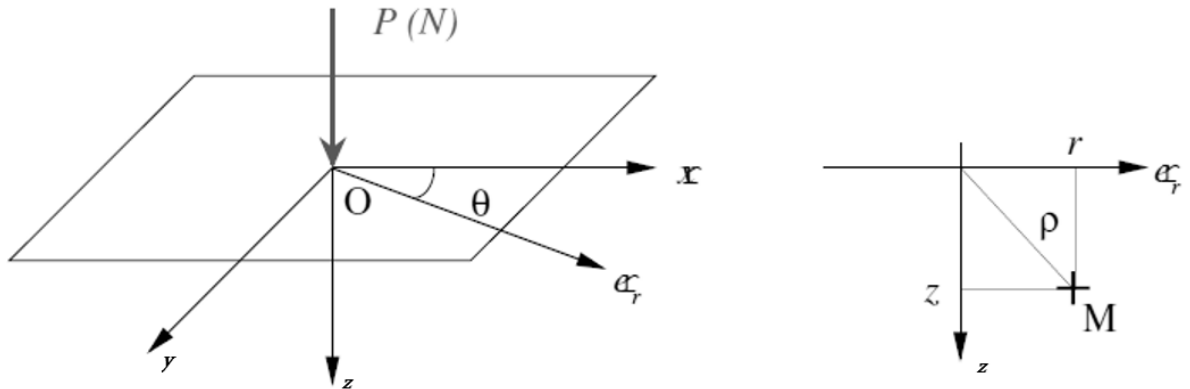

Figure 18. Concentrated normal effort

P : normal concentrated effort in N

$$\sigma_{rr} = \frac{P}{2\pi} \left[(1 - 2\nu) \left(\frac{1}{r^2} - \frac{z}{\rho r^2} \right) - \frac{3z r^2}{\rho^5} \right] \quad (58)$$

$$\sigma_{\theta\theta} = \frac{P}{2\pi} (1 - 2\nu) \left[\left(\frac{1}{r^2} - \frac{z}{\rho r^2} - \frac{z}{\rho^3} \right) \right] \quad (59)$$

$$\sigma_{zz} = \frac{3P z^3}{2\pi \rho^5} \quad (60)$$

$$\sigma_{rz} = \frac{3P r z^2}{2\pi \rho^5} \quad (61)$$

On the surface S:

$$U_r = -\frac{1-2\nu P}{4\pi G r} \quad (62)$$

$$U_z = -\frac{1-\nu P}{2\pi G r} \quad (63)$$

b) Uniform pressure on a disc

Figure 19 presents uniform pressure on a disc.

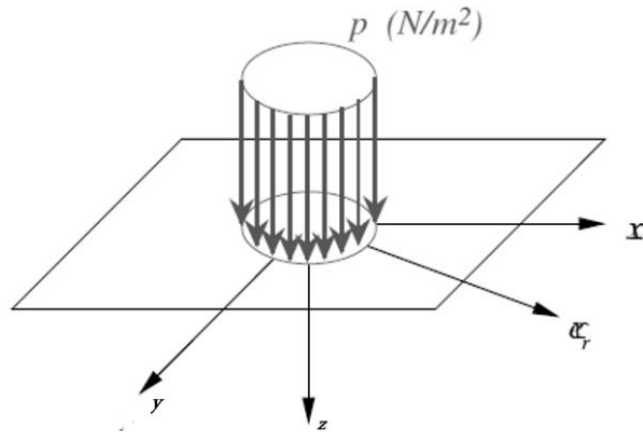

Figure 19. Uniform pressure on a disc

p : pressure (N/m^2). Along the axis (O, Z)

$$\sigma_{rr} = \sigma_{\theta\theta} = -p \left[\frac{1 + 2\nu}{2} - (1 + \nu)z(a^2 + z^2)^{-\frac{1}{2}} + \frac{z^3}{2}(a^2 + z^2)^{-3/2} \right] \quad (64)$$

$$\sigma_{zz} = -p (1 - z^3(a^2 + z^2)^{-3/2}) \quad (65)$$

c) Elliptical pressure of revolution

Figure 20 shown the elliptical pressure distribution.

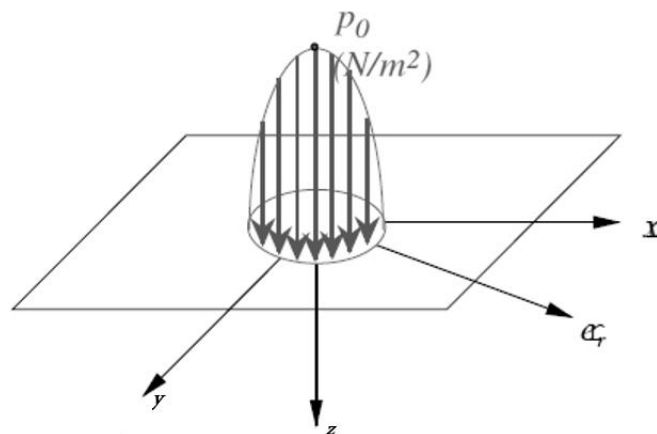

Figure 20. Elliptical pressure of revolution

P_0 : maximum pressure (N/m^2). Along the axis (O, Z)

$$\sigma_{rr} = \sigma_{\theta\theta} = -p_0(1 + \nu) \left(1 - \frac{a}{z} \arctan \frac{a}{z} \right) + \frac{1}{2} \left(1 + \frac{z^2}{a^2} \right)^{-1} \quad (66)$$

$$\sigma_{zz} = -p_0 \left(1 + \frac{z^2}{a^2}\right)^{-1} \quad (67)$$

$$\sigma_{rz} = 0 \quad (68)$$

On the loaded one ($r \leq a$) :

$$U_r = -\frac{(1-2\nu)(1+\nu)a^2}{3E} p_0 \left[1 - \left(1 - \frac{r^2}{a^2}\right)^{3/2}\right] \quad (69)$$

$$U_z = \frac{1-\nu^2}{E} \frac{\pi p_0}{4a} (2a^2 - r^2) \quad (70)$$

3.12 Friction factor and the resulting forces during the displacement of one body relative to another

3.12.1 Normal Force

A body which rests on a plane impresses a force due to its weight, we call the gravitational force $\vec{F}_g = m\vec{g}$, and the plane also prints a force on the body which is the normal force. This force is always perpendicular to the plane (see Figure 21).

When two bodies interact, the forces that they exert on each other are always equal in magnitude but in opposite directions.

$$\sum \vec{F} = 0 \Rightarrow \vec{F}_N - \vec{F}_g \Rightarrow \vec{F}_N = \vec{F}_g = m \cdot g \quad (71)$$

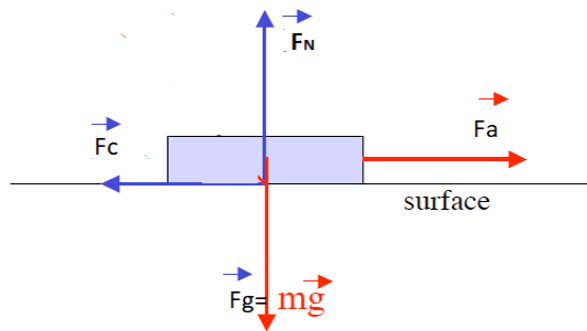

Figure 21. Force Diagram

3.12.2 Static and kinetic friction force

The two forces of static friction (F_s) and kinetic (F_c) are proportional to the normal force (F_N) and which depends on surfaces in contact according to a coefficient of friction (f):

$$F_s \leq f_s \cdot F_N \quad (72)$$

$$\text{with } f_s > f_c \Rightarrow F_c < F_s \quad (73)$$

$$F_C = f_c \cdot F_N$$

The frictional force is parallel to the plane and opposite to the force applied to the body, the latter is always parallel to the plane. Figure 22 presents the diagram of the Static and kinetic friction force.

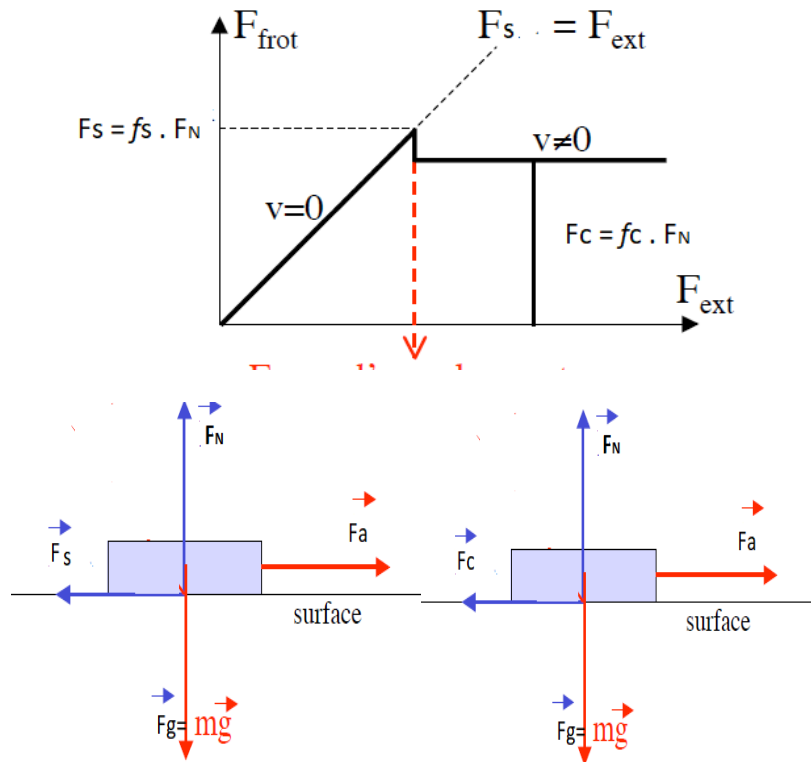

Figure 22. Diagram of the Static and kinetic friction force

3.12.3 The inclined force applied to the body with respect to the plane

The inclined force applied to the body with respect to the plane is shown in Figure 23.

Static friction force is determined as follows:

$$\sum \vec{F}_X = 0 \quad (74)$$

$$\vec{F}_S - \vec{F}_x = 0 \quad (75)$$

We have $F_x = T \cos \theta$

So
$$F_s = T \cos \theta \quad (76)$$

We remove the expression of the normal force $F_s = f_s \cdot F_N$

$$f_s \cdot F_N = T \cos \theta \Rightarrow F_N = T \cos \theta / f_s \quad (77)$$

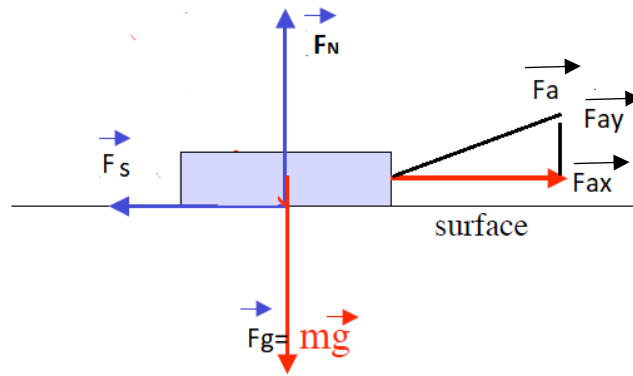

Figure 23. Force applied to the body inclined

Note:

When the body starts to move, the frictional force is reduced since the kinetic coefficient (f_c) is lower than the static coefficient (f_s). And the applied force $F_a = m.a$ is equal to the mass times the acceleration of the body, and it is the kinetic coefficient (f_c) which will intervene.

3.12.4 Friction in an inclined plane

The static friction (f_s) is maximum when the tangent of the inclined plane is important, in this case the friction force is equal to the coefficient of static friction $F_s = f_s$, it is independent of the mass and of the gravitational acceleration (see Figure 24).

If two mass bodies slide from the same angle, their static friction coefficients are the same.

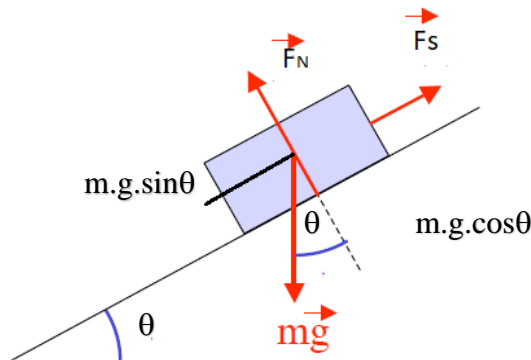

Figure 24. Friction in an inclined plane

3.13 Friction measurement

The friction measurement is part of the mechanical measurements where a coefficient of friction is calculated using a tribometer. Friction measurement is frequently used in several fields such as mechanics and machine maintenance.

A tribometer is a device used to measure in particular the coefficient of friction between two surfaces in contact, μ , and the service life of lubricants, by simulating different tribological conditions (see Figure 25).

For the system presented below, the test piece is clamped between two jaws with a force F_s . One notes the tensile force F_t . The coefficient (or factor) of friction is determined by:

$$\mu = F_t / 2 F_s \quad (78)$$

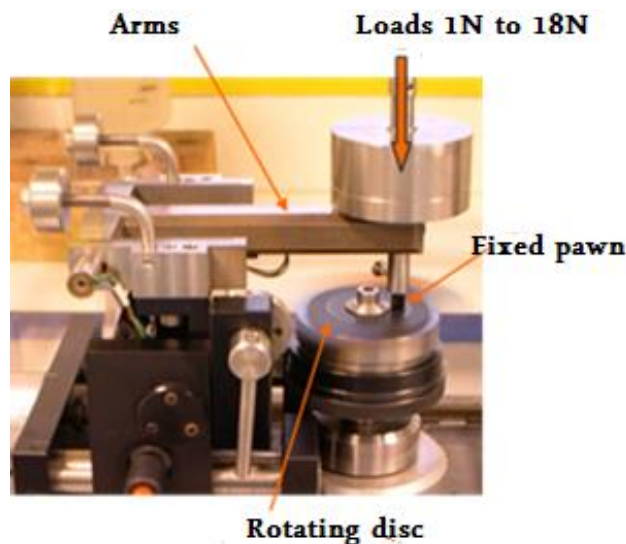

Figure 25. Tribometer

3.13.1 Other types of tribometers [6]

The Anton Paar company develops and manufactures various tribometers that allow scientists, researchers and engineers to continue their research and product development work in complete peace of mind, to manage and control manufacturing quality and to optimize their output. The different tribometers are:

*The pin-disc tribometer is used for measuring friction, wear and lubrication (see Figure 26). The pin-disc tribometer is reliable in laboratories for research and quality control of new materials (ceramics, metals, polymers), lubricants and oil additives and self-lubricating systems.



Figure 26. Pin-disc tribometer

The high temperature tribometer is showed in Figure 27, analyses friction and wear properties of materials at high temperatures is of increasing importance, especially for the development and quality control of combustion engine parts and electrical installations.

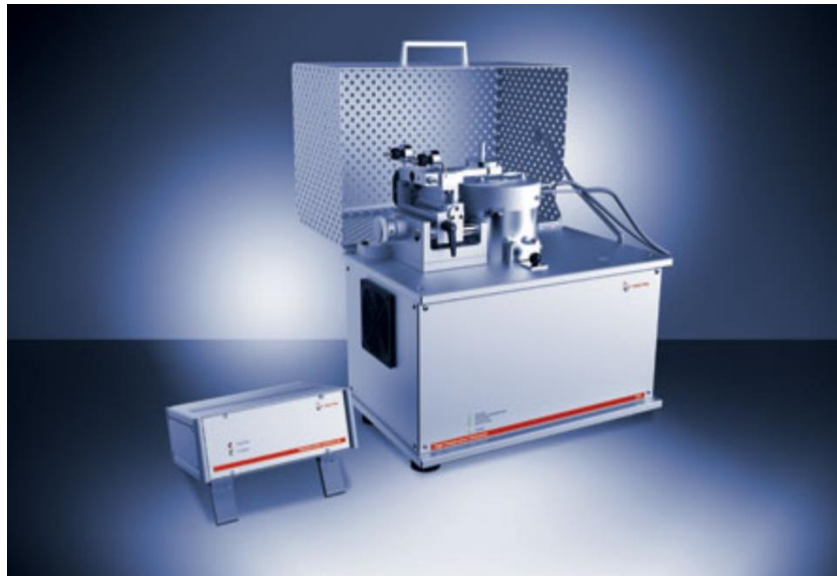

Figure 27. High temperature tribometer

*The nanotribometer is specially designed to study surface interactions at extremely low contact pressure, especially when soft materials are critical. This instrument makes it possible to study a large contact area while maintaining measurement accuracy in very small ranges of force and displacement (see Figure 28).

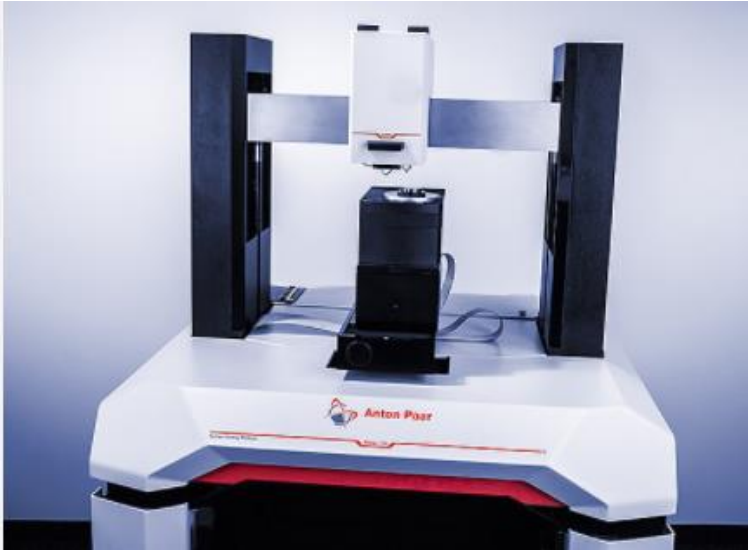

Figure 28. Nanotribometer

4. Wear [2], [5]

4.1 Adhesive Wear

Adhesive wear is the pulling of irregular material from the surface. Particles torn off from the softest material will adhere to the other surface. Adhesion depends on the surface energy of the materials in contact. A severe adhesion rate can be reached, or the surfaces are welded, the mechanism jams (Seizure), the contact pressure is very high.

4.2 Abrasive Wear

A rigid solid indents and ploughs a material which deforms plastically (soft).

- The rigid solid can be a hard particle that has entered the contact (Abrasion with three bodies).
- The rigid slide can be a particle of both surfaces (Abrasion to its bodies).

This type of wear is limited by increasing the hardness of the softer material, or reducing the plasticity index, in order to stay in the plastic and limited tillage regime.

4.3 Wear phases

Phases 1: In the first hours of operation of a mechanism, it is a phase of adaptation of the surfaces (running-in).

Phase 2: The contact enters a phase of normal wear.

Phase 3: Rapid phase of wear (End of life), the wear phase is presented in Figure 29.

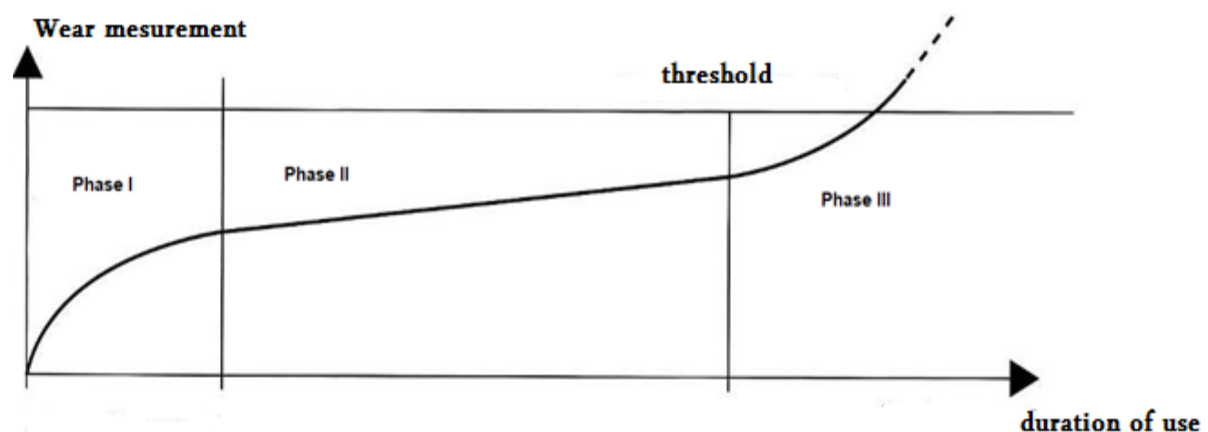

Figure 29. Wear phase

4.4 Wear rate

The volume of waste is proportional to the distance of sliding, on the other hand, more applied load W is high, the contact is high, so the wear will be high.

- The volume of waste material V is given by the following relation:

$$V = K \cdot F \cdot d \quad (79)$$

With

K : wear coefficient ($\text{mm}^3/\text{N}/\text{m}$)

d : Sliding distance (m)

F : applied force (N)

With

$$K = k / H \quad (80)$$

K : coefficient of normal wear

H : hardness

- Worn height is given by the following relation:

$$H_{\text{worn out}} = K \cdot P_n \cdot d \quad (81)$$

$$d = v \cdot T_d \quad (82)$$

So

$$H_{\text{worn out}} = K \cdot P_n \cdot v \cdot T_d \quad (83)$$

with

P_n : nominal contact pressure (N/m^2)

v : sliding speed (m/s)

T_d : lifetime (s)

For brittle materials, wear is controlled primarily by failure mechanisms, since material removal occurs through the intersection of side cracks or their propagation to the surface. The scratch wears volume of fragile materials in the following form:

$$V = \alpha \cdot K_C^n \cdot H^m \quad (84)$$

where α depends on the experimental conditions and the mechanical characteristics of the materials, and where:

$-2 < n < -3/4$ and $-1/2 < m < 1/2$.

K_C : toughness of material

5. Hydrodynamic lubrication [1]

5.1 Definition

Lubrication or greasing is a set of techniques to reduce friction, wear between two elements in contact and in movement with respect to each other. It often makes it possible to evacuate part of the thermal energy generated by this friction, as well as to avoid corrosion. In these situations, the fluid flows are parallel to the surfaces, which simplifies their description and their calculation (theory of lubrication).

5.2 Lubricated contacts

In lubricated contacts, a protective film separates the surfaces in contact. Depending on the contact pressures and the relative speed of the surfaces, different lubrication regimes may exist, depending on the operating conditions, different types of lubrication exist in lubricated systems. According to the value of the pressure in the contact, one distinguishes:

- Low pressure contacts or surface contacts, the bearings, hydrodynamic thrust bearing and radial face seals.

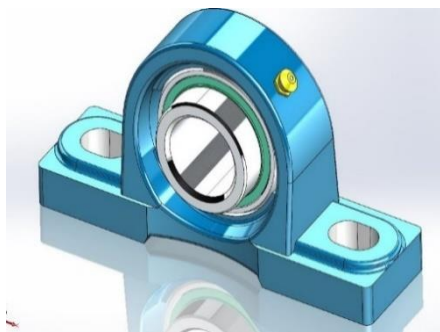

Plain bearing

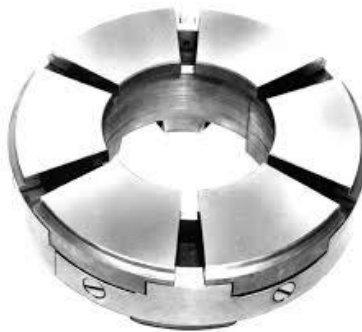

Thrust bearing



Gasket

Figure 30. Mecanisme with low pressure contacs

- High pressure contacts or radio contacts.

Bearings, gears, tappet cam systems and lip seals fall under the category of microwave contacts.



Figure 31. Mecanisme with high pressure contacts

To present a classification of the different lubrication phenomena, it is convenient to use both for surface contacts and for radio contacts, the Stribeck curve is shown in Figure 32, the first representation of which was given in 1902 in the case of a plain bearing.

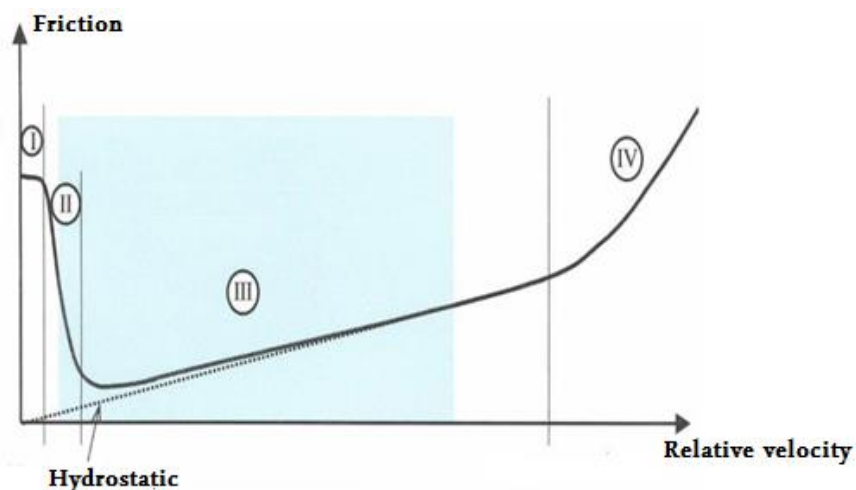

Figure 32. Stribeck curve

5.2.1 The surface contacts

The surface contact represents all the lubricated contacts for which the pressures in the film remain relatively low, that is to say less than or of the order of a few tens of Mega Pascal (a few hundred bars).

The Stribeck curve corresponds to four different lubrication regimes:

- Zone I present the limit (Boundary) lubrication,
- Zone II exposes mixed lubrication,
- Zone III shows the hydrodynamic lubrication,
- Zone IV defines non-laminar hydrodynamic lubrication.

The discontinuous line presents hydrostatic lubrication which can be carried out in laminar or non-laminar conditions.

a) Limit lubrication (Boundary lubrication)

At low speed and for moderate contact pressures, surface separation is mainly due to adsorbed oil molecules. This type of lubrication, which corresponds to zone I of the Stribeck curve, is provided by molecules of polar oil which "cling" to surfaces (see Figure 33). In fact, lubricating molecules form either epilamic monolayers of polar substances (fatty acids or soaps) which adhere to surfaces by adsorption or chemisorption or compact colloids (amorphous calcium carbonate for example) which forms a film which separates the surfaces. This type of lubrication is found in small mechanisms such as locks, sewing machines, etc.

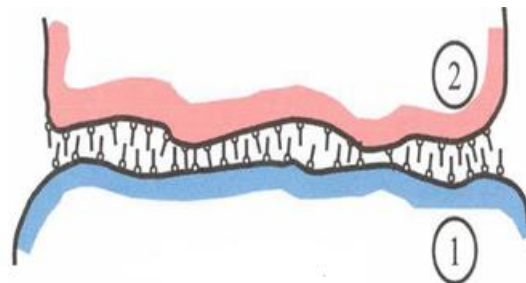

Figure 33. Limit (Boundary) lubrication

b) Mixed lubrication

Zone II corresponds to mixed lubrication. This lubrication can be seen as a transition between the boundary lubrication and hydrodynamic lubrication. This phenomenon is generally due to the roughness of the surfaces, there are converging zones in the fluid film which allow the generation of hydrodynamic pressure. Thus, part of the load is supported by fluid zones and the other part by zones where the contact is in limit lubrication (see Figure 34). The piston-rings-liner contact at top dead center and bottom dead center of the internal combustion engine cycle corresponds to this type of lubrication.

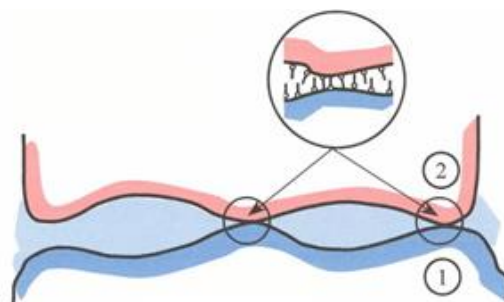

Figure 34. Mixed lubrication

c) Hydrodynamic lubrication

Zone III is a representation of hydrodynamic lubrication. The viscous lubricant is entrained in the contact which forms a convergence space in which hydrodynamic pressure develops. This pressure allows the total separation of the opposing surfaces in contact and load balancing (see Figure 35).

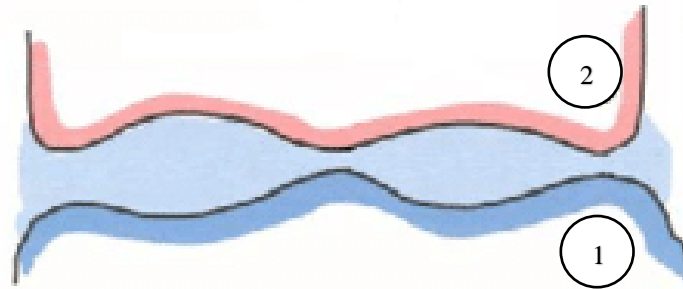

Figure 35. Hydrodynamic lubrication.

d) Hydrostatic lubrication

In zones III and IV of the Stribeck curve, the surfaces are completely separated by a fluid film. The only possible damage is due to a possible erosion linked to the impurities in suspension in the lubricant, to the cavitation phenomena which may exist in the film under dynamic loads as well as, under the effect of too high temperatures and pitting by electrical discharges.

5.2.2 Hertzian contacts

Hertzian contacts mainly concern ball or roller bearings, gears, push cam systems, elastomer lip seals. In this type of contact, the pressure generated in the film is high enough to elastically deform the surfaces and the calculation of the contact characteristics must be done by simultaneously solving the Reynolds equation and the elasticity equations. Furthermore, the viscosity of the fluid varies considerably with the pressure. The loads applied to the contact are not necessarily very large, but the surface of the contact is very small which leads to very high pressures which can be greater than 3 Giga Pascals. In the case of contact between a cylinder and a plane, the friction variation curve as a function of the rolling speed in the contact is given by Figure 36.

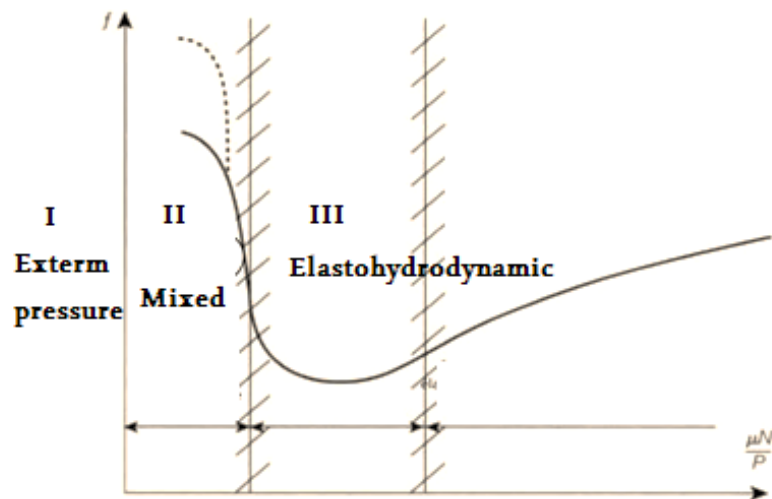

Figure 36. Hertzeien curve

This curve is similar to the Stribeck curve obtained in the case of surface contact and has three zones which correspond to three types of lubrication.

- Zone I correspond to extreme pressure lubrication,
- Zone II with mixed lubrication,
- Zone III with elastohydrodynamic lubrication.

a) Extreme pressure lubrication

In extreme pressure (EP) lubrication, the surfaces are separated by a reactive film formed by chemical reaction between the extreme pressure additives contained in the lubricant. These additives are macromolecules comprising atoms of sulphur, chlorine or phosphorus, the macromolecules are bound to the surface and protect them. Under the effect of the pressures, temperatures and high shear rates existing in the contact, the macromolecules are destroyed.

b) Mixed lubrication

Zone II corresponds to mixed lubrication, it is a transition zone. For high pressure contacts, this transition takes place between extreme pressure lubrication and elastohydrodynamic lubrication under the effect of the displacement of the surfaces, a generation of pressure is formed in the converging areas of the film with an increase in speed, progressively separates surfaces.

c) Elastohydrodynamic lubrication

Zone III corresponds to elastohydrodynamic lubrication for which the lubricant completely separates the surfaces. The determination of the characteristics of the mechanism is obtained by the simultaneous resolution of the Reynolds equation in the film and the elasticity equations.

5.3 Basic equations of hydrodynamic lubrication

In hydrodynamic lubrication, the fluid film completely separates the surfaces, which assumes that the roughness and shape defects of the surfaces have dimensions smaller than the thickness of the film. Otherwise, there will be contact at different points of the two surfaces, we will speak of either mixed lubrication or boundary lubrication. The formation and maintenance of a fluid film requires the existence of pressure in this film in order to balance the load applied between the two surfaces of the mechanism. This pressure, which in hydrodynamic lubrication is generated by an external system (pumps or compressors), in the hydrodynamic case created by the relative movement of the surfaces.

Calculating this pressure makes it possible to determine the load that the contact can support, the friction torque and the flow rate of the mechanism.

5.3.1 Reynolds equation

The Reynolds equation in lubrication can be deduced from the equations of continuous media mechanics and the law of behavior of Newtonian fluids, taking into account the particular shape of the lubricating film, for which the thickness is very small compared to the width and length of the contact.

The Reynolds equation translates the law of flow concentration in the contact:

$$\frac{\delta}{\delta x} \left(\frac{h^3}{\mu} \frac{\delta P}{\delta x} \right) + \frac{\delta}{\delta Z} \left(\frac{h^3}{\mu} \frac{\delta P}{\delta Z} \right) = 6(U_1 - U_2) \frac{\delta h}{\delta x} + 6(W_1 - W_2) \frac{\delta h}{\delta Z} + 6h \frac{\delta}{\delta x} (U_1 + U_2) + 6h \frac{\delta}{\delta Z} (W_1 + W_2) + 12V_2 \dots \dots \dots (85)$$

In Cartesian coordinates

Figure 37 where the film thickness h is measured according to the boundary conditions on the fluid velocities are:

- According to wall 1; for $y = 0$: $u = U_1$, $V = 0$, $w = W_1$
- According to wall 2; for $y = 0$: $u = U_2$, $V = V_2$, $w = W_2$

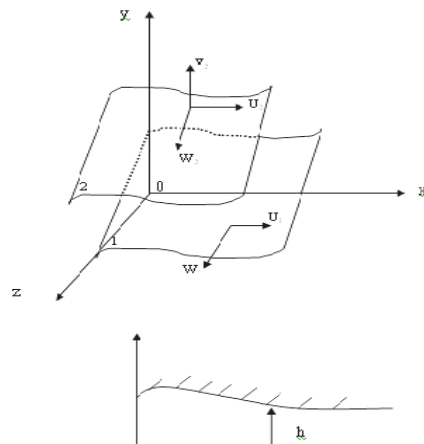

Figure 37. Système d'axe en coordonnées cartésiennes

With :

u, v, w : components of the fluid velocity in the x, y, z directions.

U_2, V_2, W_1 , and W_2 : are the velocities of surfaces 1 and 2 in the x, y, z direction

The speed V_1 of surface 1 in the y direction is zero.

P : pressure in the film

$$u = \frac{1}{2\mu} \frac{\delta P}{\delta x} y(y-h) + \frac{h-y}{h} U_1 + \frac{y}{h} U_2 \dots \dots \dots (86)$$

$$w = \frac{1}{2\mu} \frac{\delta P}{\delta z} y(y-h) + \frac{h-y}{h} W_1 + \frac{y}{h} W_2 \dots \dots \dots (87)$$

From these relations, we deduce the shear stresses in the fluid:

$$\tau_{xy} = \mu \frac{\delta u}{\delta y} = \frac{1}{2} \frac{\delta P}{\delta x} (2y-h) + (U_2 - U_1) \frac{\mu}{h} \dots \dots \dots (88)$$

$$\tau_{xz} = \mu \frac{\delta w}{\delta y} = \frac{1}{2} \frac{\delta P}{\delta z} (2y-h) + (W_2 - W_1) \frac{\mu}{h} \dots \dots \dots (89)$$

In cylindrical coordinates: r, θ, z Figure 38

h is measured in the Oz direction

Boundary conditions:

According to wall 1; for $z = 0$: $u = U_1, V = V_1, w = 0$

According to wall 2; for $z = h$: $u = U_2, V = V_2, w = W_2$

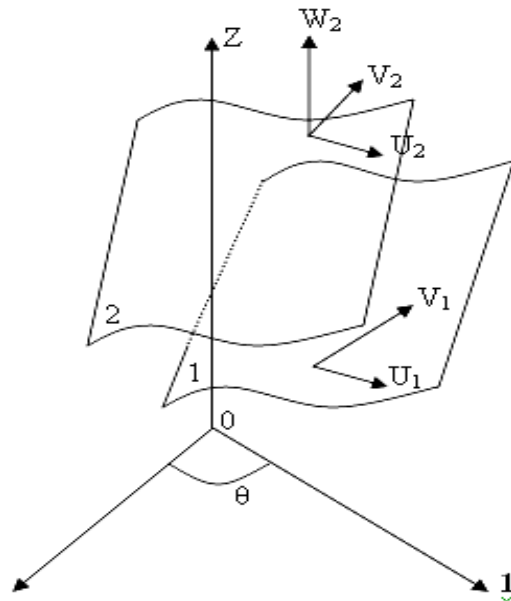

Figure 38 Système d'axe en coordonnées cylindriques

The Reynolds equation is written as:

$$\frac{\delta}{\delta r} \left(\frac{rh^3}{\mu} \frac{\delta P}{\delta r} \right) + \frac{\delta}{\delta \theta} \left(\frac{h^3}{\mu r} \frac{\delta P}{\delta \theta} \right) = 6r(U_1 - U_2) \frac{\delta P}{\delta r} + 6(V_1 - V_2) \frac{\delta h}{\delta \theta} + 6rh \frac{\delta}{\delta r} (U_1 + U_2) + 6h \frac{\delta}{\delta \theta} (U_1 + U_2) + 6h(U_1 + U_2) + 12rW_2 \dots \dots \dots (90)$$

With :

u , v: components of the fluid velocity in the radial and tangential directions are given by the relation (2.7) and (2.8) respectively:

$$u = \frac{1}{2\mu} \frac{\delta P}{\delta r} Z(Z-h) + \frac{h-Z}{h} U_1 + \frac{Z}{h} U_2 \dots \dots \dots (91)$$

$$w = \frac{1}{2\mu r} \frac{\delta P}{\delta \theta} Z(Z-h) + \frac{h-Z}{h} V_1 + \frac{Z}{h} V_2 \dots \dots \dots (92)$$

We deduce the shear stresses in the fluid:

$$\tau_{ry} = \mu \frac{\delta u}{\delta Z} = \frac{1}{2} \frac{\delta P}{\delta r} (2Z - h) + (U_2 - U_1) \frac{\mu}{h} \dots\dots\dots (93)$$

$$\tau_{\theta z} = \mu \frac{\delta V}{\delta Z} = \frac{1}{2r} \frac{\delta P}{\delta \theta} (2Z - h) + (V_2 - V_1) \frac{\mu}{h} \dots\dots\dots (94)$$

The Reynolds equation is a second-order partial differential equation of elliptic type whose main unknown is the pressure.

The value of the pressure in the film depends not only on the geometry of the contact and its kinematics but also on the boundary conditions on the pressure retained when solving the Reynolds equation.

Two types of conditions are generally used:

- 1- The boundary of the integral domain assumed to be known, with the pressure P known at all points,
- 2- The remainder of the boundary where the film is broken will be determined by an additional condition on the pressure.

5.3.2. Energy equation

The temperature field in the lubricant film is determined by solving the energy equation [20]:

$$\rho C_p \left(\frac{u}{R^2} \frac{\partial T}{\partial \theta} + v \frac{\partial T}{\partial y} + w \frac{\partial T}{\partial z} \right) = K \frac{\partial^2 T}{\partial y^2} + \mu \left[\left(\frac{\partial u}{\partial y} \right)^2 + \left(\frac{\partial w}{\partial y} \right)^2 \right] \dots\dots\dots (95)$$

Furthermore, THD analysis involves the treatment of heat transfer in the pad using the Laplace equation:

$$\frac{\partial^2 T_c}{\partial r_c^2} + \frac{1}{r_c} \frac{\partial T_c}{\partial r_c} + \frac{1}{r_c^2} \frac{\partial^2 T_c}{\partial \theta_c^2} + \frac{\partial^2 T_c}{\partial z_c^2} = 0 \dots\dots\dots (96)$$

In order to determine the temperature field, the following thermal boundary conditions are applied:

- Continuity of heat flow at the pad/film interface is imposed.
- The average temperature at the leading edge is obtained using a heat flux balance in the groove.
- A zero energy balance determines the temperature at the oil film and shaft interface.

For lubricants, the dynamic viscosity μ_L depends on the temperature field, the Mac Coull and Walther relationship can be used:

$$\log_{10} \log_{10} \left(\frac{\mu_L(\theta, y, z)}{\rho_L} + a \right) = -m \log_{10} [T(\theta, y, z)] + n \dots \dots \dots (98)$$

Where the coefficients m and n depend on the nature of the lubricant and are determined by two viscosity values obtained for different temperatures. For the coefficient a takes a value of $0.6 \text{ mm}^2 \cdot \text{s}^{-1}$ is applied, as commonly used in numerical simulations.

5.3.3 The pressure field for two parallel plates

a) Stretching effect

Consider a flow between two parallel flat plates of infinite width according to Oz. The upper plate of length B is fixed. The lower plate moves by stretching with a translational speed $U_1 = U(x)$ (see figure 39).

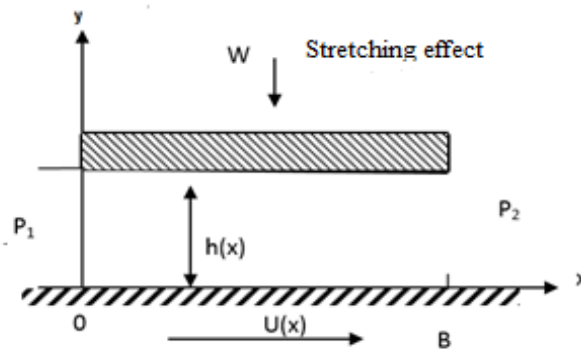

Figure 39. Stretching effect

Reynolds equaton:

$$\frac{\partial^2 p}{\partial x^2} = \frac{6 \mu}{h^2} \frac{dU}{dx} \quad (99)$$

$$\frac{dp}{dx} = \frac{6 \mu}{h^2} U + C_1 \quad (100)$$

$$p = \frac{6 \mu}{h^2} \int U dx + C_1 x + C_2 \quad (101)$$

C_1 and C_2 are determined by the boundary conditions, the pressure is given by

$$P = -\frac{3\mu A}{h^2} x (B - x) \quad (102)$$

5.3.4 The pressure field for two non-parallel plates

Consider the flow between two non-parallel plates of infinite width along Oz. The lower plate is animated by a uniform translational motion of speed $U_1 = U$, the upper plate is stationary and inclined in the plane xOy of a α very small angle, figure (40).

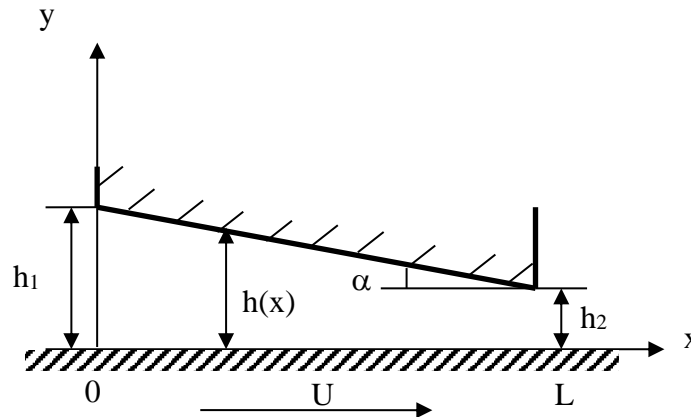

Figure 40. Oil wedge

For two non-parallel surfaces, the Reynolds equation is written:

$$\frac{d}{dx} \left(h^3 \frac{dp}{dx} \right) = 6\mu U \frac{dh}{dx} \dots\dots\dots (103)$$

$$\text{Let } \frac{dp}{dx} = 6\mu U \frac{h - h^*}{h^3} \dots\dots\dots (104)$$

Where h^* represents the film thickness at the abscissa point x^* for which the pressure gradient vanishes.

The thickness of the film can be characterized in different ways. We will use the expression:

$$h = h_2 + (L - x) \text{tg} \alpha \dots\dots\dots (105)$$

Where h_2 is the minimum film thickness;

L is the length of the film

$$\text{tg} \alpha = (h_1 - h_2) / L \text{ the slope of the inclined plane.}$$

To integrate the Reynolds equation it is necessary to write it as a function of the film thickness h only by setting:

$$dh = -dx \text{ tg} \alpha \dots\dots\dots (106)$$

It comes after integration:

$$P = \frac{6\mu U}{\text{tg}\alpha} \left(\frac{1}{h} - \frac{h^*}{2h^2} + C_1 \right) \dots\dots\dots(107)$$

If the film inlet and outlet are at atmospheric pressure and if this is taken as a reference; the following boundary conditions must be taken.

Boundary conditions:

$$\left. \begin{aligned} p = 0 \text{ for } x = 0 \text{ or } h = h_1 \\ p = 0 \text{ for } x = L \text{ or } h = h_2 \end{aligned} \right\} \dots\dots\dots(108)$$

These conditions allow us to calculate the two constants h^* and C_1 ; it also follows:

$$h^* = \frac{2h_1h_2}{h_1 + h_2} \text{ and } C_1 = -\frac{1}{h_1 + h_2} \dots\dots\dots(109)$$

The pressure field is therefore given by the following relation:

$$P = \frac{6\mu U}{\text{tg}\alpha} \left[\frac{1}{h} - \frac{1}{h^2} \cdot \frac{h_1h_2}{(h_1 + h_2)} - \frac{1}{h_1 + h_2} \right] \dots\dots\dots(110)$$

References

- [1] Frene J., Nicolas D., Degueurce B., Berthe D. et Godet M., « Lubrification hydrodynamique : Paliers et Butées » Collection de la direction des études et recherche d'électricité de France n°72, Edition Eyrolle, (1999).
- [2] Noël Brunetière, « Introduction à la TRIBOLOGIE », Institut Pprime Futuroscope 2016
- [3] Cazaud R., « Le frottement et l'usure des métaux, les antifriction ». Dunod (1959).
- [4] Colloch S., Dureisseix D., Marquis D., « Mécanique de contact », Licence de Technologie-Mécanique. Université de Pierre et Marie Curie- Ecole normale supérieur de Cachan, 2017.
- [5] Ligier J.L. et Gojon R., « Prédiction de l'usure et du grippage d'un palier de moteur Diesel », SIA 93065.
- [6] <https://www.anton-paar.com/fr-fr/produits/groupe/tribometre/>
- [7] Frene J. « Butées et paliers hydrodynamiques ». Techniques de l'Ingénieur, Génie mécanique, B 5 320, août 1995.
- [8] Pan C.H.T. "Gas bearings. Tribology, Friction, Lubrification and Wear". Chapter 4. Hemisphere Publishing Corporation, 1980.