

International Review of Automatic Control (IREACO)

Theory and Applications

Contents:

Modeling, Analysis and Stability of Consensus Condition in Heterogeneous and Switching Multi Agent Systems	537
<i>by Sabato Manfredi</i>	
On Exponential Almost Sure Stability of Consensus Algorithm in State Dependent and Switching Networks	544
<i>by Sabato Manfredi, Paris Pennesi</i>	
An Adaptive Measurement Fusion Scheme for Drifted and Biased Sensors Fault Isolation	552
<i>by Sabato Manfredi, Stefania Santini</i>	
Predictive Control Based on Discrete Laguerre Network	558
<i>by J. Škultéty, E. Miklovičová, R. Bars</i>	
Review of Intelligent Control System	565
<i>by Abdullah J. H. Al Gizzi, M. W. Mustafa</i>	
Harmonics Mitigation Under Various Loading Conditions of PWM Current Controlled APF Using Fuzzy Logic Controller	589
<i>by D. Mohan Reddy, T. Govri Manohar</i>	
Performance Evaluation of Positive Output Switched Capacitor Elementary Luo Converter with PI and Fuzzy Controllers	601
<i>by A. Joseph Basanth, S. P. Natarajan, N. Muruganandham</i>	
An Open Loop Evaluation of Five Phase Z-Source Inverter	607
<i>by M. S. Bakar, N. A. Rahim, K. H. Ghazali, H. Daniyal</i>	
Biologically Inspired Decentralized Target Location Estimation Using Neural Networks	612
<i>by Mathew Mithra Noel, Ankit Sharma</i>	
Fundamental Studies of a Three Phase Cascaded H-Bridge and Diode Clamped Multilevel Inverters Using Matlab/Simulink	618
<i>by Rosli Omar, Mohammed Rasheed, Marizan Sulaiman</i>	
Visualizing Power Frequency Dynamics Using D-Partitioning	626
<i>by C. Kiranu, K. Yanev, M. T. Oladiran</i>	

(continued on outside back cover)



Praise Worthy Prize

International Review of Automatic Control (IREACO)

Editorial Board:

Srinivasan Alavandar	(India)	Indian Institute of Technology, Roorkee
Boris Andrievsky	(Russia)	Russian Academy of Sciences - Institute for Problems of Mechanical Eng.
Frank Callier	(Belgium)	University of Namur (FUNDP) – Department of Mathematics
Jose B. Cruz	(U.S.A.)	Ohio State University - Department of Electrical and Computer Engineering
Mingcong Deng	(Japan)	Okayama University - Department of Systems Engineering
Zhengtao Ding	(U.K.)	University of Manchester - Control Systems Centre
Hans Peter Geering	(Switzerland)	Institute for Dynamic Systems and Control (IDSC)
Hamid Reza Karimi	(Norway)	University of Agder- Faculty of Technology and Science
Juš Kocijan	(Slovenia)	Jožef Stefan Institute
Ju-Jang Lee	(Korea)	KAIST - Division of Electrical Engineering
Guoping Liu	(U.K.)	University of Glamorgan - Faculty of Advanced Technology
Markos Papageorgiou	(Greece)	Technical University Of Crete - Dynamic Systems & Simulation Laboratory
Sirkka-Liisa Jämsä-Jounela	(Finland)	Helsinki University of Technology - Automation Technology Laboratory
Yang Shi	(Canada)	University of Saskatchewan - Department of Mechanical Engineering
Houria Siguerdidjane	(France)	Supelec – Département Automatique
Desineni Subbaram Naidu	(U.S.A.)	Idaho State University - Measurement and Control Eng. Research Center
Ryszard Tadeusiewicz	(Poland)	AGH Univ. of Science and Technology - Faculty of Mining and Metallurgy
Jiandong Wang	(China)	Peking University –Department of Industrial Engineering and Management
Hong Wang	(U.K.)	University of Manchester - Control Systems Centre
Qian-Chuan Zhao	(China)	Tsinghua University - Department of Automation (CFINS)

The *International Review of Automatic Control (IREACO)* is a publication of the **Praise Worthy Prize S.r.l.**
The Review is published bimonthly, appearing on the last day of January, March, May, July, September, November.

Published and Printed in Italy by **Praise Worthy Prize S.r.l.**, Naples, September 30, 2013.

Copyright © 2013 Praise Worthy Prize S.r.l. - All rights reserved.

This journal and the individual contributions contained in it are protected under copyright by **Praise Worthy Prize S.r.l.** and the following terms and conditions apply to their use:

Single photocopies of single articles may be made for personal use as allowed by national copyright laws.

Permission of the Publisher and payment of a fee is required for all other photocopying, including multiple or systematic copying, copying for advertising or promotional purposes, resale and all forms of document delivery. Permission may be sought directly from **Praise Worthy Prize S.r.l.** at the e-mail address:

administration@praiseworthyprize.com

Permission of the Publisher is required to store or use electronically any material contained in this journal, including any article or part of an article. Except as outlined above, no part of this publication may be reproduced, stored in a retrieval system or transmitted in any form or by any means, electronic, mechanical, photocopying, recording or otherwise, without prior written permission of the Publisher. E-mail address permission request:

administration@praiseworthyprize.com

Responsibility for the contents rests upon the authors and not upon the **Praise Worthy Prize S.r.l.**

Statement and opinions expressed in the articles and communications are those of the individual contributors and not the statements and opinions of **Praise Worthy Prize S.r.l.** **Praise Worthy Prize S.r.l.** assumes no responsibility or liability for any damage or injury to persons or property arising out of the use of any materials, instructions, methods or ideas contained herein.

Praise Worthy Prize S.r.l. expressly disclaims any implied warranties of merchantability or fitness for a particular purpose. If expert assistance is required, the service of a competent professional person should be sought.

Nonlinear Observer and Backstepping Control of Quadrotor Unmanned Aerial Vehicle

M. A. Larbi, K. Zemalache Meguenni, Y. Meddahi, M. Litim

Abstract – This article presents the general concept of two nonlinear observers, such as high gain, sliding mode, adapted with nonlinear Backstepping control of quadrotor. The Positions is estimated by observers and set against reaction for control. The observatory technique using for estimated the non-measurable states has fine to reduce the number of sensors embedded in the $x4$ -flying system. Several simulation tests in Simulink / Matlab are carried and takes into account an external disturbances (wind) to demonstrate the performance of the system controller-observer. **Copyright © 2013 Praise Worthy Prize S.r.l. - All rights reserved.**

Keywords: Nonlinear Observer, High Gain, Sliding Mode, Backstepping.

Nomenclature

$B(O', x, y, z)$	Frame attached to G
$E(O, X, Y, Z)$	Inertial frame with Ez upwards
$\xi = [x, y, z]^T$	Position vector
$\alpha = [\varphi, \theta, \psi]^T$	Euler angles yaw, pitch and roll
R	Rotation matrix
G	Vehicle center of mass
m	Total mass of the vehicle
ω_i	Angular velocity of rotor i ($i = 1, 4$), rad/s
U_i	Collective force, N
$J = \text{diag}(I_x, I_y, I_z)$	Body inertia
F_i	Force developed by rotor, i
l	Distance from G to the rotor, i
τ_f	Moment according to B frame

I. Introduction

The intention of the researchers to humanize the machine, their will to reproduce the capacities human or animal of perception and action in the robotized systems and with the miniaturization of the sensors, the actuators and the technological maturity of embarked electronics; the advanced in the automatic and the artificial intelligence led to the quick evolution of the flying robots UAV [1]-[22]. These air vehicles caused a great interest thanks to their, maneuverability, capacity to carry out vertical takeoffs and landings and their large field of application as well military as civil, especially when the human intervention becomes difficult or dangerous.

A good control of a process passes in general by good information on this last. To ensure optimal control, it is also necessary to have knowledge complete or partial of the state of the system considered. However, in much of situations practical, for technical reasons or economic (construction, positioning and/or cost of the sensors), it is

not always possible to reach all the variables of state of a system. Consequently, one is often brought to what is called rebuild the state of the system by using a «software sensor» or an observer.

The observer is a dynamic system based on the knowledge of the mathematical model describing the behavior of a system and using the entries and the measurements acquired on this one in order to rebuild the variables of state.

The use of an observer can be planned to answer three categories of objectives to knowing, the monitoring, the detection of failures and control (Fig. 1).

The rebuilding of the state of a dubious system is also a traditional problem of the automatic. Luenberger [15] studied a reconstruction of state, to which its name was allotted. The observer of Luenberger is not always sufficient, because the error in estimation generated by this observer for a dubious system or at unknown entries does not converge forcing towards the zero value.

To cure this problem, we can use the observers of the singular systems [16] or the observers at unknown entries [17], the problem of design of observers with action proportional and integral.

An observer-controller in [19], the observer is with sliding mode of a higher order, it with the absolute position and the angle of the lace, it rebuilds speeds of the helicopter and estimating the disturbances. As in [20], the observer is a differentiator with slipping mode of order 2 which considers the orders virtual of the Backstepping.

In this paper, the model form presented [2] that established by Lozano [6] by the method of Euler-Lagrange and that of Bouabdallah [4].

Then, the Backstepping controller and motion planning are combined to stabilize the helicopter by using the point to point steering stabilization. Modeling is briefly described Section II.

Section III describes Backstepping controllers. Section IV, synthesis of non linear observer is presented, In Section V, simulation results are presented followed by Robustness consideration in Section V. Finally, some conclusions and future work are given in the last section.

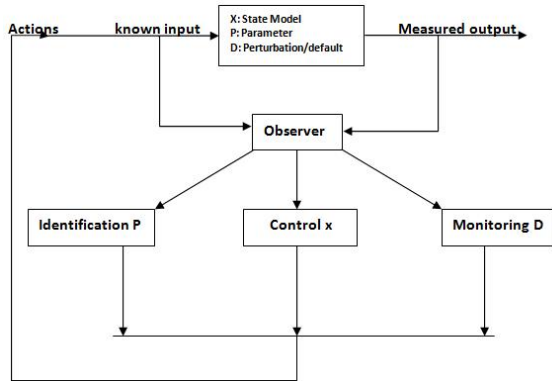

Fig. 1. Objectives of observer

II. Dynamic Modeling of Quadrotor

The mini quadrotor is four rotors helicopter, Fig. 2, each rotor consists of an electrical DC motor, a drive gear and propeller. The two pairs of propellers (1, 3) and (2, 4) turn in opposite directions. Forward motion is accomplished by increasing the speed of the rear rotor while simultaneously reducing the forward rotor by the same amount.

Aft, left and right motion work in the same way. Yaw command is accomplished by accelerating the two clockwise turning rotors while decelerating the counter-clockwise turning rotors. This helicopter is one of the most complex flying systems that exist. This is due partly to the number of physical effects (Aerodynamic effects, gravity, gyroscopic, friction and inertial counter torques) acting on the system [2]. We consider a local reference airframe $B(O', x, y, z)$ attached to the center of mass G of the vehicle. The center of the mass is located at the intersection of the two rigid bars. The inertial frame is denoted by $E(O, X, Y, Z)$ such that the vertical direction E_z is upwards. The absolute position of center of mass of quadrotor is described by $\xi = [x, y, z]^T$, and its attitude by the three Euler's angles $\alpha = [\varphi, \theta, \psi]^T$, these three angles are respectively pitch angle, roll angle and yaw angle.

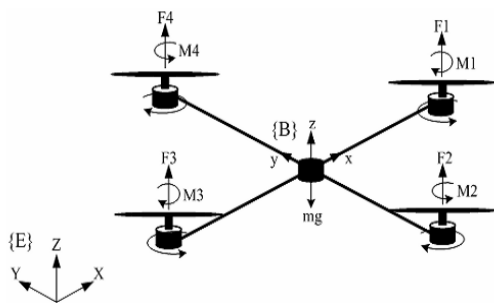

Fig. 2. Quadrotor configuration model

The transformation rotation between the earth reference frame and the body reference frame is given by the following matrix:

$$R = \begin{pmatrix} C_\theta C_\psi & C_\psi S_\theta S_\phi - C_\phi S_\psi & C_\phi C_\psi S_\theta + S_\phi S_\psi \\ C_\theta S_\psi & S_\theta S_\phi S_\psi + C_\phi C_\psi & C_\phi S_\theta S_\psi - C_\psi S_\phi \\ S_\theta & C_\theta S_\phi & C_\theta C_\phi \end{pmatrix} \quad (1)$$

with $S(\cdot)$ and $C(\cdot)$ represent $\sin(\cdot)$ and $\cos(\cdot)$ respectively.

II.1. Translation Motion

Under these assumptions, it is possible to describe the fuselage dynamics as that of a rigid body in space to which come to be added the aerodynamic forces caused by the rotation of the rotors. Using the formalism of Newton-Euler, the dynamic equations are written in the following form:

$$\begin{cases} \dot{R} = RS(\Omega) \\ F_f + F_{dt} + F_G = m\ddot{\xi} \\ \tau_f - \tau_a - \tau_g = J\dot{\Omega} + \Omega \wedge J\Omega \end{cases} \quad (2)$$

where m is the mass of the structure and $J = \text{diag}(I_x, I_y, I_z) \in R^{3 \times 3}$ is a symmetric positive definite constant inertia matrix of the quadrotor with respect to B , F_f, F_{dt} and F_G are respectively the forces generated by the propeller system, the drag force and the gravity force, such as:

$$F_{dt} = K_{dt}\dot{\xi} \quad (3)$$

where $K_{dt} = \text{diag}(K_{dtx}, K_{dty}, K_{dtz})$ are the translation drag coefficients:

$$F_G = mG \quad (4)$$

with $G = [0, 0, g]^T$ is gravity vector.

The forces generated by the propeller system of the quadrotor are given by the following equations [2]:

$$F_f = \begin{bmatrix} C_\phi C_\psi S_\theta + S_\phi S_\psi \\ C_\phi S_\theta S_\psi - C_\psi S_\phi \\ C_\theta C_\phi \end{bmatrix} \sum_{i=1}^4 F_i \quad (5)$$

F_i is the lift force generated by the rotor i and it's proportional to the square of the angular speed rotation.

Using the dynamic Eq. (2) of translation becomes:

$$m\ddot{\xi} = F_f - K_{dt}\dot{\xi} - mG \quad (6)$$

II.2. Rotational Motion

Using the Newton's law about the rotation motion, the sum of moments is given as follow (2), the \wedge denotes the product vector, and Ω is the angular speed expressed in body fixed frame [3]:

$$\Omega = M\dot{\alpha} \quad (7)$$

with:

$$M = \begin{pmatrix} 1 & 0 & -S_\theta \\ 0 & C_\phi & C_\theta S_\phi \\ 0 & -S_\phi & C_\phi C_\theta \end{pmatrix}$$

τ_f the moment developed by the quadrotor according to the body fixed frame is given by:

$$\tau_f = \begin{bmatrix} l(F_3 - F_1) \\ l(F_4 - F_2) \\ M_1 - M_2 + M_3 - M_4 \end{bmatrix} \quad (8)$$

with l the distance between the quadrotor center of mass and the rotation axe of propeller and M_i the quadrotor moment developed about z axis, τ_a is the aerodynamic friction torque:

$$\tau_a = K_{af}\Omega \quad (9)$$

and $K_{af} = \text{diag}(K_{afx}, K_{afy}, K_{afz})$ is the aerodynamic friction coefficients. τ_g is the gyroscopic torque, given by:

$$\tau_g = \sum_{i=1}^4 \Omega \wedge J_r \begin{bmatrix} 0 \\ 0 \\ \omega_i \end{bmatrix} \quad (10)$$

with ω_i is angular speed of rotor i , and J_r is the rotor inertia. Consequently the complete dynamic model which governs the quadrotor is as follows:

$$\begin{cases} \ddot{\phi} = \frac{1}{J_x} \{ (J_y - J_z) \dot{\theta} \psi + J_r \dot{\theta} \bar{\Omega} + dU_2 \} \\ \ddot{\theta} = \frac{1}{J_y} \{ (J_z - J_x) \dot{\phi} \psi - J_r \dot{\phi} \bar{\Omega} + dU_3 \} \\ \ddot{\psi} = \frac{1}{J_z} \{ (J_x - J_y) \dot{\phi} \dot{\theta} + U_4 \} \\ \ddot{x} = \frac{1}{m} \{ (C_\phi S_\theta C_\psi + S_\phi S_\psi) U_1 \} \\ \ddot{y} = \frac{1}{m} \{ (C_\phi S_\theta C_\psi - S_\phi S_\psi) U_1 \} \\ \ddot{z} = \frac{1}{m} \{ (C_\phi S_\theta U_1) - g \} \end{cases} \quad (11)$$

The vectors U_1, U_2, U_3 and U_4 are the control of the system to the engine airframe including forces generated by the motors and drag terms.

III. Control of the Quadrotor

The choice of this method is considering because the major advantages it presents [2]:

- It ensures Lyapunov stability.
- It ensures the robustness and all properties of the desired dynamics.
- It ensures the handling of all system nonlinearities.

The model (11) developed in the first part of this paper can be rewritten in the state-space form: $\dot{x} = f(x) + g(x, u)$ and $x = [x_1, \dots, x_{12}]^T$, is the state vector

of the system such as:

$$x = [\phi \ \dot{\phi} \ \theta \ \dot{\theta} \ \psi \ \dot{\psi} \ x \ \dot{x} \ y \ \dot{y} \ z \ \dot{z}]^T \quad (12)$$

From (11) and (12) we obtain the following state representation:

$$f = \begin{cases} \dot{x}_1 = x_2 \\ \dot{x}_2 = a_1 x_4 x_6 + a_2 x_4 \bar{\Omega} + b_1 U_2 \\ \dot{x}_3 = x_4 \\ \dot{x}_4 = a_3 x_2 x_6 + a_4 x_2 \bar{\Omega} + b_2 U_3 \\ \dot{x}_5 = x_6 \\ \dot{x}_6 = a_5 x_2 x_4 + b_3 U_4 \\ \dot{x}_7 = x_8 \\ \dot{x}_8 = \frac{U_1}{m} U_x \\ \dot{x}_9 = x_{10} \\ \dot{x}_{10} = \frac{U_1}{m} U_y \\ \dot{x}_{11} = x_{12} \\ \dot{x}_{12} = \frac{c x_1 c x_3}{m} U_1 - g \end{cases} \quad (13)$$

with:

$$\begin{cases} a_1 = \left(\frac{I_y - I_z}{I_x} \right), a_2 = \left(\frac{I_r}{I_x} \right) \\ a_3 = \left(\frac{I_z - I_x}{I_y} \right), a_4 = \left(-\frac{I_r}{I_y} \right) \\ a_5 = \left(\frac{I_x - I_y}{I_z} \right) \\ b_1 = \left(\frac{d}{I_x} \right), b_2 = \left(\frac{d}{I_y} \right), b_3 = \left(\frac{1}{I_z} \right) \end{cases} \quad (14)$$

and:

$$\begin{cases} U_x = (C x_1 S x_3 C x_5 + S x_1 S x_5) \\ U_y = (C x_1 S x_3 C x_5 - S x_1 S x_5) \end{cases} \quad (15)$$

We note that the system is in a form triangular waterfall can be controlled by Backstepping control.

III.1. Backstepping Controller

The Backstepping Kanellakopoulos was developed by [05], and inspired by the work of Feurre & Morse [7], Sussmann and Kokotovic & [11]. The basic idea is to let some system states act as virtual inputs.

The Backstepping uses a form of system integrators chain after a coordinate transformation for a triangular system based on the direct method of Lyapunov. The method consists of fragmented system into a set of subsystem nested descending order.

From the, it is possible to design systematically and recursively controllers and corresponding Lyapunov functions [9] [10] [12].

The algorithm Backstepping is described step by step in the following. We consider the tracking error:

$$z_i = \begin{cases} x_{id} - \hat{x}_i & /i \in \{1,3,5,11\} \\ \hat{x}_i - \dot{x}_{(i-1)d} - \alpha_{(i-1)}z_{(i-1)} & /i \in \{2,4,6,12\} \end{cases} \quad (16)$$

Using the all Lyapunov functions as:

$$V_i = \begin{cases} \frac{1}{2}z_i^2 & /i \in \{1,3,5,11\} \\ \frac{1}{2}(z_i^2 + V_{i-1}^2) & /i \in \{2,4,6,12\} \end{cases} \quad (17)$$

Application of algorithm:

For $i = 1$:

$$\begin{cases} z_1 = x_{1d} - \hat{x}_1 \\ V_1 = \frac{1}{2}z_1^2 \end{cases}$$

and:

$$\dot{V}_1 = z_1 \dot{z}_1 = z_1(\dot{x}_{1d} - \dot{\hat{x}}_1) \quad (18)$$

Using the Lyapunov functions and especially $\dot{V}_i < 0$, the stabilization of z_1 can be obtained by introducing a virtual control input x_2 such that:

$$\hat{x}_2 = \dot{x}_{1d} + \alpha_1 z_1 \quad \text{with } \alpha_1 > 0$$

The Eq. (18) is then: $\dot{V}_1(z_1) = -\alpha_1 z_1^2$. We consider a variable change by making:

$$z_2 = \hat{x}_2 - \dot{x}_{1d} - \alpha_1 z_1^2$$

For $i = 2$:

$$\begin{cases} z_2 = \hat{x}_2 - \dot{x}_{1d} - \alpha_1 z_1^2 \\ V_1 = \frac{1}{2}z_1^2 + \frac{1}{2}z_2^2 \end{cases}$$

and:

$$\dot{V}_1 = z_1 \dot{z}_1 + z_2 \dot{z}_2$$

Finally:

$$\dot{z}_2 = a_1 \hat{x}_4 \hat{x}_6 + a_2 \hat{x}_4 \bar{\Omega} + b_1 U_2 - \ddot{x}_{1d} + \alpha_1 \dot{z}_1 \quad (19)$$

We achieve the control U_2 that give (19) equal to $\alpha_2 z_2$, with α_2 is positive constant, the final control is:

$$U_2 = \frac{1}{b_1} \{-a_1 \hat{x}_4 x_6 - a_2 \hat{x}_4 \bar{\Omega} + \ddot{\psi}_d + \alpha_1(\dot{\psi}_d - x_2) - \alpha_2 z_2 + z_1\} \quad (20)$$

The term $\alpha_2 z_2$ is added in order to stabilize z_1 . The same steps are taken again in order to extract U_1, U_3, U_4 (eq. (21)):

$$\begin{cases} U_1 = \frac{m}{(Cx_1 Cx_3)} [g + \ddot{z}_d + \alpha_7(\dot{z}_d - \hat{x}_{12}) - \alpha_8 z_8 + z_7] \\ U_3 = \frac{1}{b_2} [-a_3 \hat{x}_2 \hat{x}_6 - a_4 \hat{x}_2 \bar{\Omega} + \ddot{\theta}_d + \alpha_3(\dot{\theta}_d - \hat{x}_4) - \alpha_4 z_4 + z_3] \\ U_4 = \frac{1}{b_3} [-a_5 \hat{x}_2 \hat{x}_4 + \ddot{\psi}_d + \alpha_5(\dot{\psi}_d - \hat{x}_6) - \alpha_6 z_6 + z_5] \end{cases}$$

Or them α_i (with $i \in [1..8]$) are positive constant.

IV. Observer Design

IV.1. A high Gain Observer

The high gain observer [13] [22] is used in the case of uniformly observable systems [18]. This type of observer is interesting because it can be applied to a broad class of systems which includes the drone system studied.

The dynamic model of quadrotor on state space given in (13), and denote \hat{x} the estimate of the state vector (12).

The observer design of the state variables can be represented in the following state space form:

$$\begin{cases} \dot{\hat{x}}_1 = \hat{x}_2 + \Lambda_1 \\ \dot{\hat{x}}_2 = a_1 \hat{x}_4 \hat{x}_6 + a_2 \hat{x}_4 \bar{\Omega} + b_1 U_2 + \Lambda_2 \\ \dot{\hat{x}}_3 = \hat{x}_4 + \Lambda_3 \\ \dot{\hat{x}}_4 = a_3 \hat{x}_2 \hat{x}_6 + a_4 \hat{x}_2 \bar{\Omega} + b_2 U_3 + \Lambda_4 \\ \dot{\hat{x}}_5 = \hat{x}_6 + \Lambda_5 \\ \dot{\hat{x}}_6 = a_5 \hat{x}_2 \hat{x}_4 + b_3 U_4 + \Lambda_6 \\ \dot{\hat{x}}_7 = \hat{x}_8 + \Lambda_7 \\ \dot{\hat{x}}_8 = \frac{U_1}{m} U_{\hat{x}} + \Lambda_8 \\ \dot{\hat{x}}_9 = \hat{x}_{10} + \Lambda_9 \\ \dot{\hat{x}}_{10} = \frac{U_1}{m} U_{\hat{y}} + \Lambda_{10} \\ \dot{\hat{x}}_{11} = \hat{x}_{12} + \Lambda_{11} \\ \dot{\hat{x}}_{12} = \frac{C \hat{x}_1 C \hat{x}_3}{m} U_1 - g + \Lambda_{12} \end{cases} \quad (22)$$

The observer error dynamics are given by:

$$\begin{cases} \dot{e}_1 = e_2 - \Lambda_1 \\ \dot{e}_2 = a_1 \Delta_{x_4 x_6} + a_2 e_4 \bar{\Omega} - \Lambda_2 \\ \dot{e}_3 = e_4 - \Lambda_3 \\ \dot{e}_4 = a_3 \Delta_{x_2 x_6} + a_4 e_2 \bar{\Omega} - \Lambda_4 \\ \dot{e}_5 = e_6 - \Lambda_5 \\ \dot{e}_6 = a_5 \Delta_{x_2 x_4} - \Lambda_6 \\ \dot{e}_7 = e_8 - \Lambda_7 \\ \dot{e}_8 = \frac{U_1}{m} (U_x - U_{\hat{x}}) - \Lambda_8 \\ \dot{e}_9 = e_{10} - \Lambda_9 \\ \dot{e}_{10} = \frac{U_1}{m} (U_y - U_{\hat{y}}) - \Lambda_{10} \\ \dot{e}_{11} = e_{12} - \Lambda_{11} \\ \dot{e}_{12} = \frac{U_1}{m} (U_z - U_{\hat{z}}) - \Lambda_{12} \end{cases} \quad (23)$$

with:

$$\begin{cases} \Delta_{x_4 x_6} = x_4 x_6 - \hat{x}_4 \hat{x}_6 \\ \Delta_{x_2 x_6} = x_2 x_6 - \hat{x}_2 \hat{x}_6 \\ \Delta_{x_4 x_6} = x_4 x_2 - \hat{x}_4 \hat{x}_2 \end{cases} \quad (24a)$$

and:

$$U_z = Cx_1Cx_3, U_{\bar{z}} = C\hat{x}_1C\hat{x}_3 \quad (24b)$$

with:

$$\begin{cases} a_1\Delta_{x_4x_6} + a_2e_4\bar{\Omega} = g_1 \\ a_3\Delta_{x_2x_6} + a_4e_2\bar{\Omega} = g_2 \\ a_5\Delta_{x_2x_4} = g_3 \end{cases} \quad (25)$$

The corrector gains it's calculated for the estimation errors dynamics is stable so, it was noted that the observer gains are functions of measurement errors such as:

$$\Lambda_i = l(e_1, e_3, e_5, e_7, e_9, e_{11}) \quad (26)$$

We take the first two equations of dynamic errors and explain how to choose the observer gains:

$$\begin{cases} \dot{e}_1 = e_2 - \Lambda_1 \\ \dot{e}_2 = g_1 - \Lambda_2 \end{cases} \quad (27)$$

with:

$$\begin{cases} \Lambda_1 = K_1e_1 \\ \Lambda_2 = K_2e_1 \end{cases} \text{ with: } (K_1, K_2)\mathcal{R}^{+2} \quad (28)$$

Gains K_1, K_2 are chosen such that: $K_1 = \frac{\alpha_1}{\varepsilon}, K_2 = \frac{\alpha_2}{\varepsilon^2}$.

First one chooses the gains to be exponential convergence of the linear part of the error. Second, we consider the nonlinear part as a perturbation and thus try to annul: if we choose $\varepsilon \ll 1$, and we do a change of variable $Y_1 = \frac{e_1}{\varepsilon}, Y_2 = e_2$.

We note that although the decrease in the parameter ε reduces the error of observation, and there is a convergence in minimum time.

The same steps are followed to extract others corrector gains.

IV.2. Sliding Mode Observer

In order to increase the robustness against modeling errors and uncertainty, observers based on the theory of variable structure systems are proposed [14] [21].

They are generally used for uncertain nonlinear dynamical systems. We present syntheses of observer [1][08] applied for nonlinear systems described by (13).

We define a state observer whose structure is:

$$\dot{\hat{x}} = \hat{f}(\hat{x}, y, u) + \Lambda I_s \text{ with } \hat{x} \in \mathcal{R}^n \quad (29)$$

and \hat{f} of the model f, Λ is the gain matrix ($n \times r$) determining and I_s is a vector ($r \times 1$):

$$I_s = [\text{sign}(s_1), \text{sign}(s_2) \dots \text{sign}(s_i)]^T$$

with $s_i = (y_i - \hat{y}_i)$.

The surface dimension r given by $S = 0$, is attractive if: $\hat{S}_i s_i < 0, i \in \{1, \dots, r\}$, Lyapunov condition verify,

This condition defines the area of the sliding mode.

The second stages, the gain matrix patches is to satisfy the following invariance condition:

$$\dot{s} = 0 \text{ and } s = 0$$

IV.3. Application

Consider the model on state space (13) of the quadrotor, and the observer design of the state variables represented in (22) state space, and the observer error dynamics are given in (23), we can calculate the gain matrix by nonlinear sliding mode observer, we take the two first Eqs. (27) (28) of dynamic errors and explain how to choose the observer gains:

$$\begin{cases} \dot{e}_1 = e_2 - \Lambda_1 \\ \dot{e}_2 = g_1 - \Lambda_2 \end{cases} \quad (30)$$

with:

$$\begin{cases} \Lambda_1 = \lambda_1 \text{sign}(e_1) \\ \Lambda_2 = \lambda_2 \text{sign}(e_1) \end{cases} \quad (31)$$

Errors should converge to the equilibrium values in two steps:

Step 1: We consider only the first observation error:

$$\dot{e}_1 = e_2 - \lambda_1 \text{sign}(e_1) \quad (32)$$

Slippage observation errors on the sliding surface is guaranteed by λ_1 . Let the Lyapunov function: $V_1 = \frac{e_1^2}{2}$, and their derivative $\dot{V}_1 = e_1(e_2 - \lambda_1 \text{sign}(e_1))$, with a choice of $\lambda_1 > |e_2|$ for $t < t_1$ observation error converges to zero after a finite time t_1 .

Step 2: In this step λ_2 imposes the dynamic observation errors on the sliding surface. We set: $V_2 = \frac{e_1^2}{2} + \frac{e_2^2}{2}$, and drive $\dot{V}_2 = e_2(g_1 - \lambda_2 \text{sign}(e_1)) = e_2(g_1 - \lambda_2 \frac{e_2}{\lambda_1})$; choosing $\frac{\lambda_2}{\lambda_1} > |g_1|$. So after t_1 , the sliding surface is reached and the error e_2 converges to zero in a finite time $t_2 < t_1$. The same steps are followed to extract others corrector gains, so:

$$\begin{cases} \Lambda_3 = \lambda_3 \text{sign}(e_3) \\ \Lambda_4 = \lambda_4 \text{sign}(e_3) \\ \Lambda_5 = \lambda_5 \text{sign}(e_5) \\ \Lambda_6 = \lambda_6 \text{sign}(e_5) \\ \Lambda_7 = \lambda_7 \text{sign}(e_7) \\ \Lambda_8 = \lambda_8 \text{sign}(e_7) \\ \Lambda_9 = \lambda_9 \text{sign}(e_9) \\ \Lambda_{10} = \lambda_{10} \text{sign}(e_9) \\ \Lambda_{11} = \lambda_{11} \text{sign}(e_{11}) \\ \Lambda_{12} = \lambda_{12} \text{sign}(e_{11}) \end{cases} \quad (33)$$

V. Simulations Results

The simulation results are obtained based on the following real parameters [9], an application has been run with wind disturbance (F_z) along the z direction, the strength is set to 6N, occurring at $t=10s$.

V.1. A High Gain Observer

Fig. 3, illustrates the controlled states using backstepping controller where (U_r, U_x, U_y) , denote the command signals for z , x and y directions respectively.

Fig. 4, shows the perfect convergence from tracking trajectories, and the good estimated for the high gain observer.

Fig. 5, show the Zoom of the acceptable error in direction z response, this error present because of the introduce of the wind disturbance, The annihilation of be possible her in addition the integrator effect, but the convergence of observers states is perfectly.

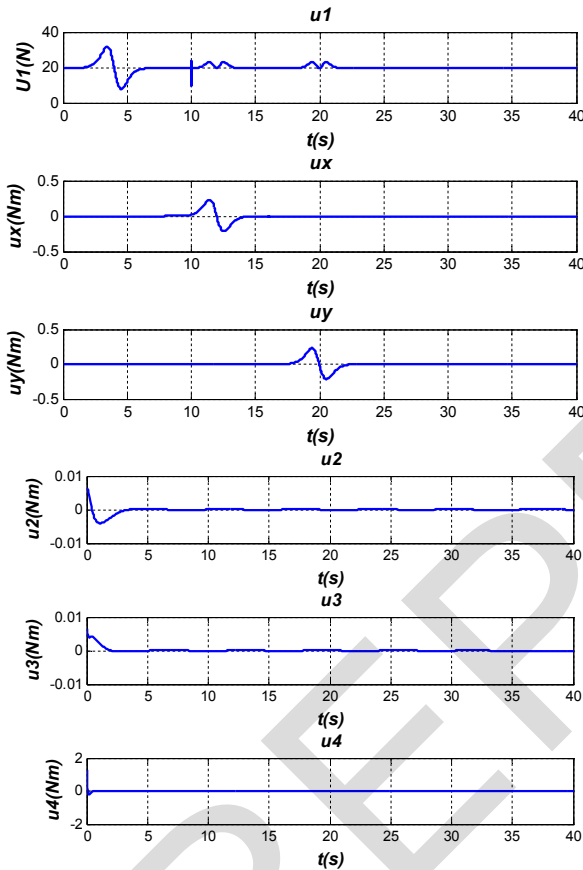

Fig. 3. Backstepping control signals with wind disturbance (6N)

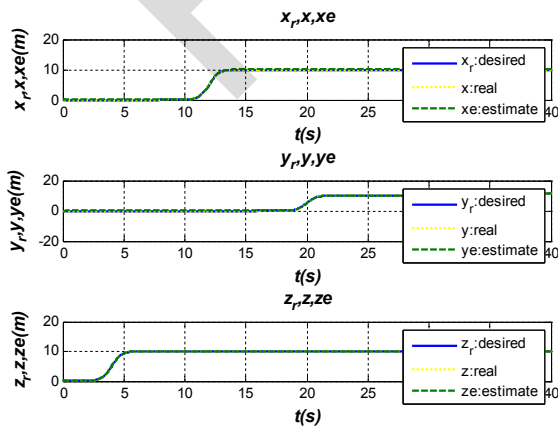

Fig. 4. Tracking simulation results with wind disturbance (6N)

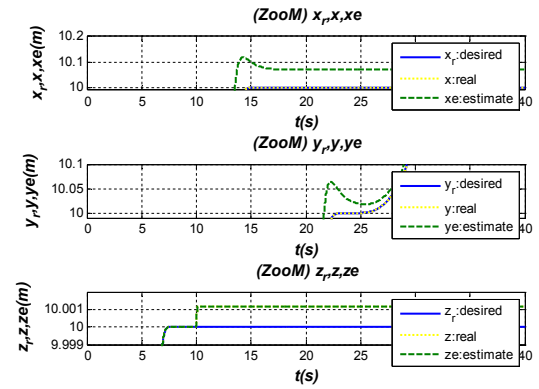

Fig. 5. Tracking simulation results Zoom with wind disturbance (6N)

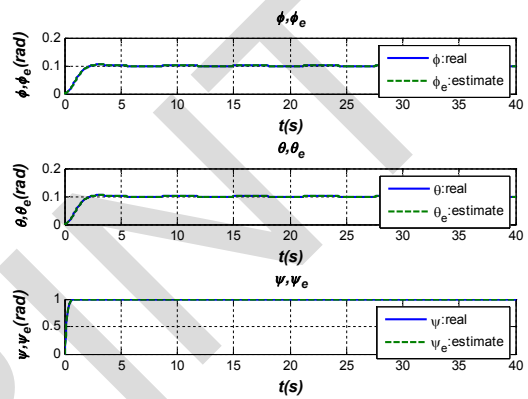

Fig. 6. The pitch (theta) roll (phi) and yaw (psi) angles

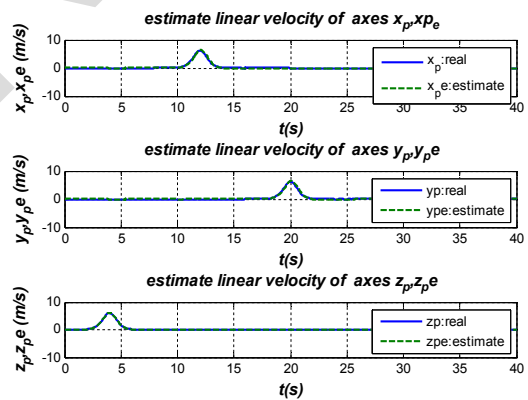

Fig. 7. Linear velocity results

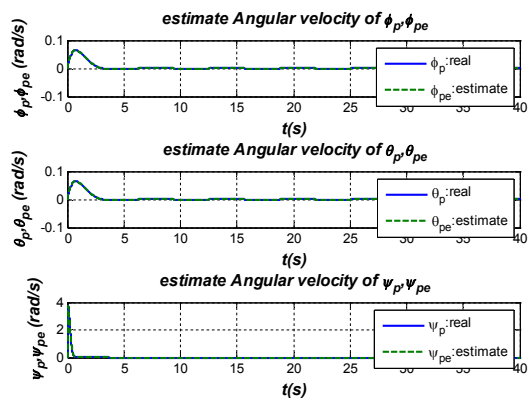

Fig. 8. Angular velocity results

Figure 6, represents the results of the real Euler's angles and their estimated, are tend to zero value after finished of the maneuverer.

Figs. 7 and 8, show the Linear velocity and the angular velocity results respectively, and notice the efficiency of the observer.

Fig. 9, illustrates the tracking errors with presence the wind disturbance, we notice that the tracking is effective, and the errors which vanish after a finite time with a perfect convergence. But the error along z direction is tend to constant value near to zero because of the presence of disturbance, this which confirm the result in Fig. 4. Fig. 10 and 11, represents the observer errors, of the position (x,y,z), and the linear velocity ($\dot{x}, \dot{y}, \dot{z}$) of the X4-flyer. We notice that the observation is good since the error tend to zero, This signifying the perfect convergence. Fig. 12, shows the perfect convergence and following of desired trajectory by the real one and the observer states the evolution of the Drone and its stabilization in 3D displacement.

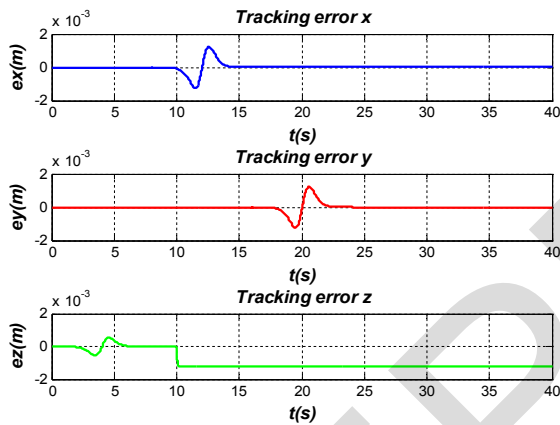

Fig. 9. Tracking errors

V.2. Sliding Mode Observer

It is concluded from the simulations, made without wind disturbance, that the sliding mode observer (SMO) gives satisfactory results.

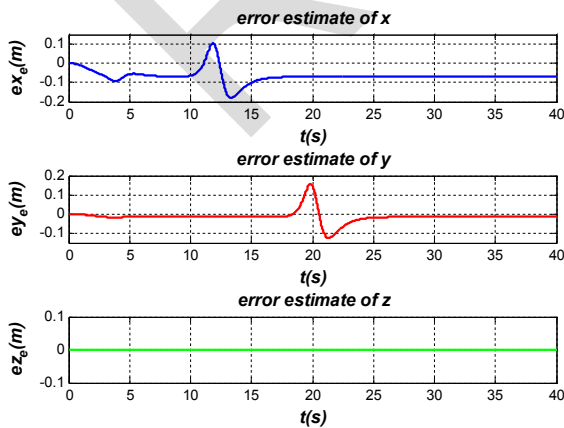

Fig. 10. Observation errors (x,y,z)

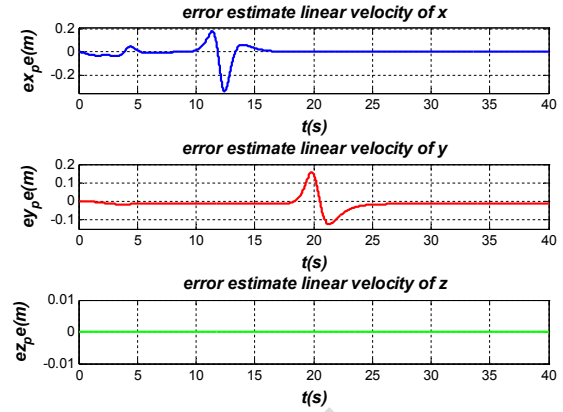

Fig. 11. Observer error for linear velocity

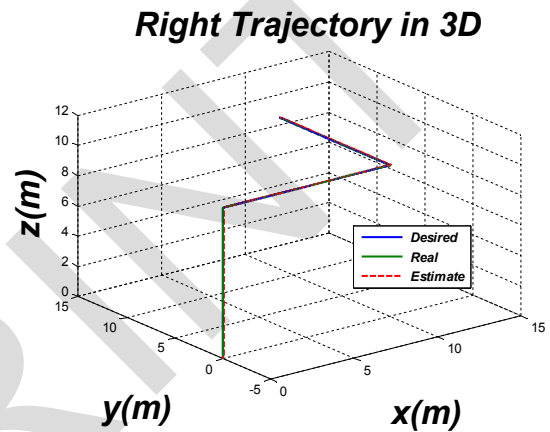

Fig. 12. Tracking trajectory in 3D

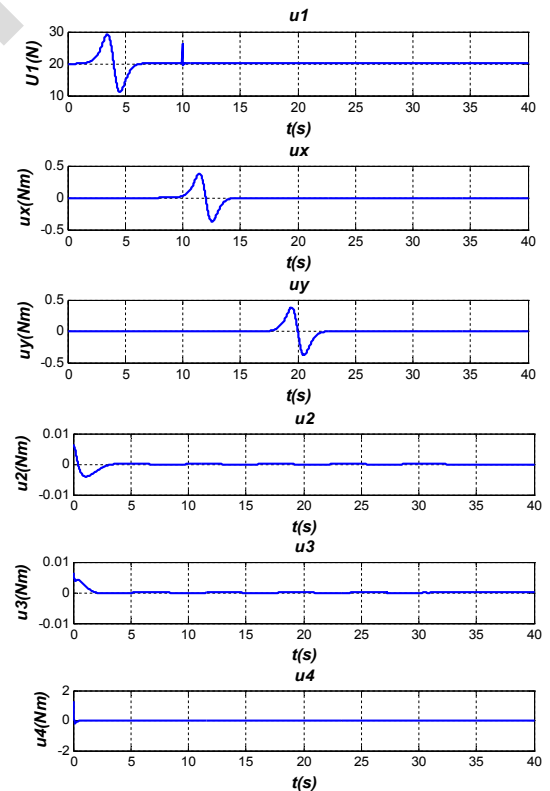

Fig. 13. Backstepping control signals with wind disturbance (6N)

The results of estimation errors given in Figs. 20 and 21 of position and linear velocity respectively show the efficiency of the observer, and notice the sliding mode observer give the best result compared with a high gain observer (HGO). Fig. 19 see the tracking errors which vanish after a finite time with a perfect convergence.

When wind disturbances are introduced the Figs. 14, 15 and 19 reflect the robustness of the close loop observer-controller, and the perfect convergence of the

real and estimate states given by (SMO) compared with (HGO). Figs. 16, 17 and 18, are present the real and estimate Euler's angles, Linear velocity and the angular velocity results respectively, we notice the best convergence and the efficiency of the observer (SMO). Fig. 22, illustrate. The 3D displacement with straight connection, we notice the good convergence of the real and the observer states to desired trajectory.

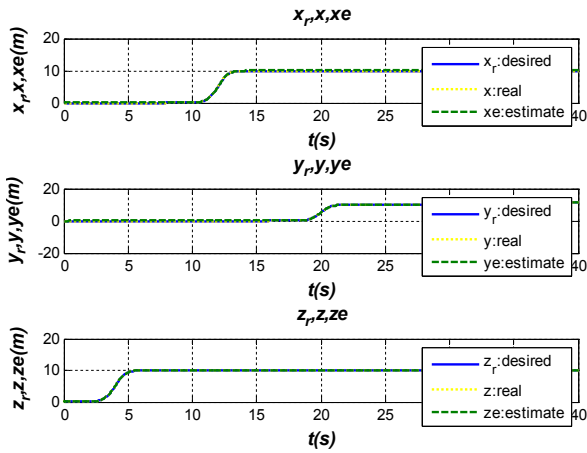

Fig. 14. Tracking simulation results with wind disturbance (6N)

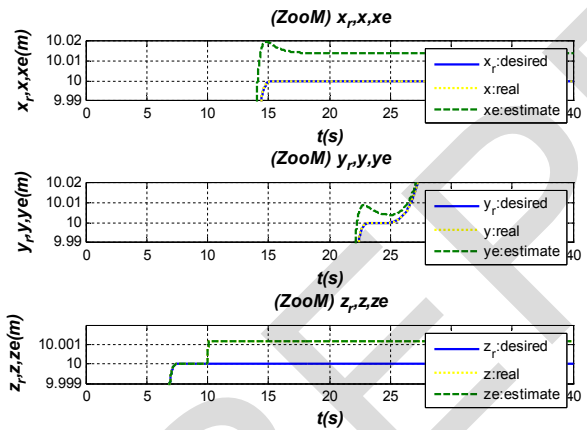

Fig. 15. Tracking simulation results Zoom with wind disturbance (6N)

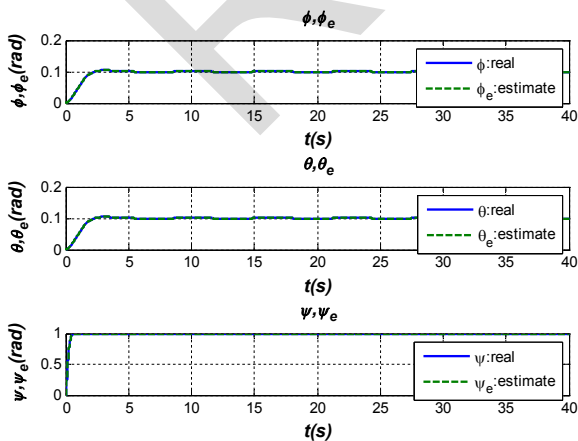

Fig. 16. The pitch (θ) roll (ϕ) and yaw (ψ) angles.

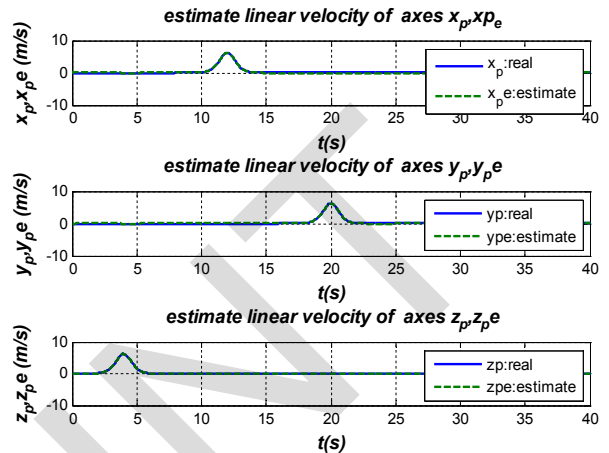

Fig. 17. Linear velocity results

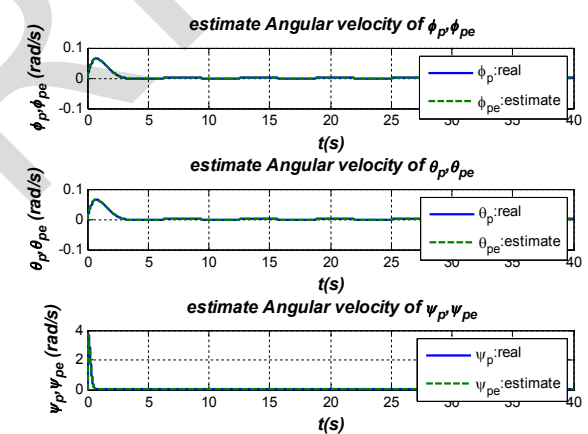

Fig. 18. Angular velocity results

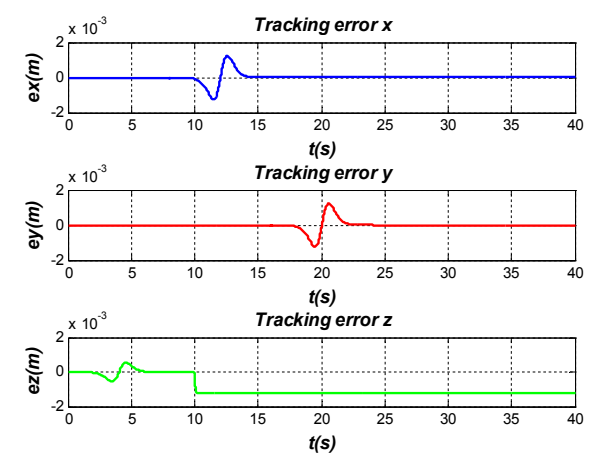

Fig. 19. Tracking errors

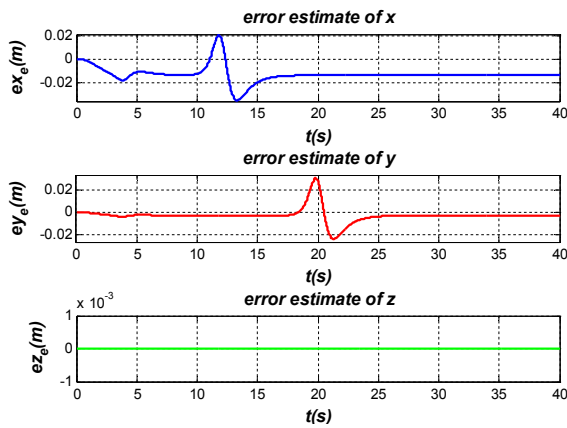

Fig. 20. Observation errors (x,y,z)

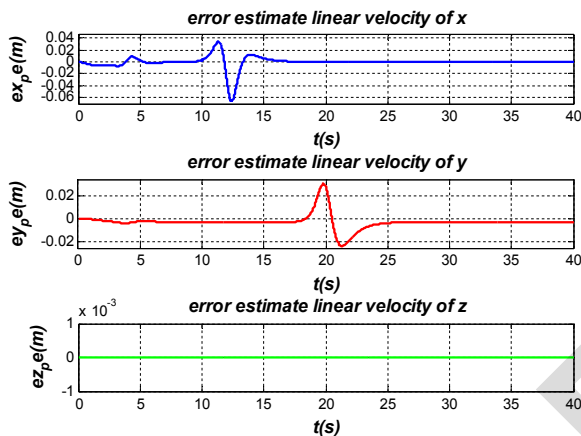

Fig. 21. Observer error for linear velocity

Right Trajectory in 3D

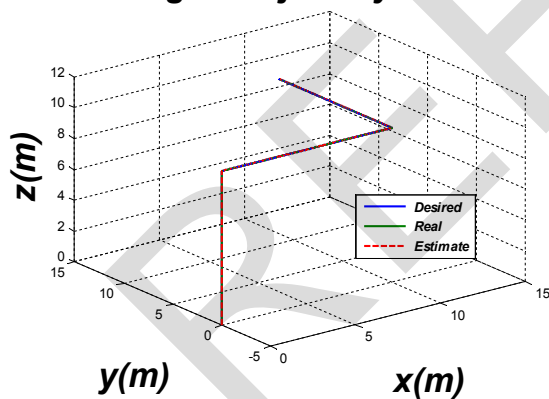

Fig. 22. Tracking trajectory in 3D

VI. Conclusion

In this paper, we studied a dynamic modeling of flyer engine called X4-flyer. We have considered in this work the stabilizing/tracking control and the observation problem for the three decoupled displacements of the engine. The objectives are to test the capability of the two observers called sliding mode and high gain observer. A comparison between SMO and HGO is given and discuss.

The use of an observer sliding mode in the Backstepping control of quadrotor seems simple and effective, with their robust appearance, the sliding mode bring to scheme of control the robustness via the observer through a rapid convergence and guarantee estimated states to real states, the command completes the objectives of stability and performance robustness with the estimated states.

Like prospects to be approached in the future, the consideration of the problem of asymmetry in the structure of the quadrotor which can considerably deteriorate the stability and the performances of any even robust order, of the moment which count does not hold any. The higher order sliding mode observer seems also very interesting to apply to a system such as the quadrotor.

References

- [1] D. Elleuch, T. Damak, Adaptive Sliding Mode Observer for a Class of Systems, *International Journal of Electrical and Computer Engineering*, vol. 5(6): 368-374, 2010.
- [2] Derafa. L, Madani. T, and Benallegue. A, dynamic modeling and experimental identification of four rotor helicopter parameters, *IEEE International Conference on Industrial Technology, Mumbai, India, pp.1834 – 1839, December2006.*
- [3] V. Mistler, A. Benallegue, N. K. M'Sirdi, Exact linearization and on interacting control of 4 rotors helicopter via dynamic feedback, *ROMAN*, pp. 586 – 593, *September 2001.*
- [4] S. Bouabdallah, P. Murrieri and R. Siegwart, Design and control of an indoor microquadrotor , *IEEE International conference on Robotics and Automation, New Orleans, USA, Vol.5, pp. 4393 – 4398, 2004.*
- [5] I. Kanellakopoulos, systematic design of adaptive controllers for feedback linearisable Systems, *IEEE . Transaction on automatic control Vol. 36(11): pp 1241-1253, July 2000.*
- [6] R. Lozano, P. Castillo and A. Dzul, Stabilization of a mini rotorcraft having four rotors, *Proceedings of IEEE/RSJ International Conference on Intelligent Robots and Systems*, pp. 2693 – 2698, 2004.
- [7] A. Feurrel, A. S. Morse, Adaptive control of single-input, single-output linear systems, *IEEE Transaction on automatic control, Vol. 23 (4), pp 557-569, July 2000.*
- [8] Abdellah, A., Abdelhafid, A., Mostafa, R., Using an Utkin observer based controller for a trajectory tracking of an overhead crane system, (2013) *International Review of Automatic Control (IREACO)*, 6 (3), pp. 316-321.
- [9] K. M. Zemalache, Tahar. M, Benhadria. M, et al, Integral backstepping controller for an autonomous helicopter, (2010) *International Review of Aerospace Engineering (IREASE)*, 3 (5), pp 257–267.
- [10] K. M. Zemalache, L. Beji, H. Maaref, Two Inertial Models of X4-Flyers Dynamics, Motion Planning and Control, *Journal of the Integrated Computer-Aided Engineering (ICAE)*, Vol.14, No. 2, pp. 107-119, *January 2007.*
- [11] P.V. kokotovic, and H.J. Sussman, A positive real condition for global stabilization of nonlinear systems, *systems & control letters Vol.13, pp 125_133, juillet 2000.*
- [12] Moutchou, M., Abbou, A., Mahmoudi, H., Induction machine speed and flux control, using vector-sliding mode control, with rotor resistance adaptation, (2012) *International Review of Automatic Control (IREACO)*, 5 (6), pp. 804-814.
- [13] G. Bornard and H. Hammouri, A high gain observer for a class of uniformly observable systems. *In Conference on Decision and Control CDC'91, pp.1494–1496, Brogton, Angleterre, 1991.*
- [14] M. Valenti, G. P. Tourmier and J. P. How, Estimation and control of a quadrotor vehicle using monocular vision and moire patterns ,*AIAA Guidance, Navigation and Control Conference and Exhibit, 2006.*

- [15] Cherifi, D., Miloud, Y., Tahri, A., New fuzzy luenberger observer for performance evaluation of a sensorless induction motor drive, (2013) *International Review of Automatic Control (IREACO)*, 6 (4), pp. 381-392.
- [16] F. L. Lewis, A survey of linear singular systems, *Circuits Systems Signal Process*, Vol. 5, pp. 3-36, 1986.
- [17] J. Chen and H. Zhang, Robust detection of faulty actuators via unknown input observers, *International Journal of Systems Science*, Vol. 22, pp. 1829-1839, 1991.
- [18] G. Conte, C.H. Moog, and A.M. Perdon. Nonlinear Control System - An Algebraic Setting. *Springer-Verlag, London, 1999*.
- [19] A. Benallegue, A. Mokhtari and L. Fridman, High-order sliding-mode observer for a quadrotor UAV, *International journal of robust and nonlinear control*, Vol.18, (4-5): pp. 427-440 2007.
- [20] T. Madani and A. Benallegue, Backstepping Control with Exact 2-Sliding Mode Estimation for a Quadrotor Unmanned Aerial Vehicle , *Proceedings of the 2007 IEEE/RSJ International Conference on Intelligent Robots and Systems, San Diego, USA*, pp.141 – 146, 2007.
- [21] M. GUISSER, H. MEDROMI, H. IFASSIOUEN, J. SAADI and N. radhy, A Coupled Nonlinear Discrete-Time Controller and Observer Designs for Underactuated Autonomous vehicles with Application to a Quadrotor Aerial Robot, *IEEE Industrial Electronics, IECON-32nd Annual Conference on*, pp.1- 6,2006.
- [22] J.P. Gauthier, H. Hammouri, and S. Othman, A simple observer for nonlinear systems applications to bioreactors, *IEEE Transactions on Automatic Control*, Vol. 37(6):875-880, 1992

Authors' information



Larbi Mohamed Elamine was born in Relizan Algeria on June 25, 1986. He received both his license in automatic and Master in automation and control of intelligent industrial system from the automatic department, University of Sciences and Technology, Oran (USTO). He is currently a researcher in nonlinear robust control and observation in LDEE laboratory.



Kadda Zemalache Meguenni received the Dipl.-Ing. Degree in Electrical Engineering from University of Sciences and Technology of Oran M-B (USTO), Algeria, in 1998, in 2001, Master Degree from USTO M-B and received the Dr.-Ing. Degree from Evry University, France, in 2006. His research interests include nonlinear control of mechanical systems, robotics, control system analysis and design tools for under-actuated systems with applications to space and aerospace vehicles (X4-flyer, vehicles).



Meddahi Youssouf received the Master Degree in Electrical Engineering from University of Sciences and Technology of Oran (USTO-MB), Algeria, in 2009. His research interests include nonlinear control of mechanical systems, control system analysis and design tools for under-actuated systems with applications to aerospace vehicles in LDEE laboratory.

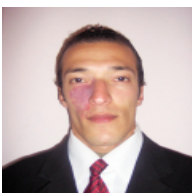

Mustapha Litim was born in Oran Algeria in July 20, 1985. He received the diploma of Master degree on automation and control of intelligent industrial systems in 2009, from the automatic department, University of Sciences and Technology, Oran (USTO). Currently, he is a PHD Student at the (LDEE) laboratory of (USTO), Algeria. His research interests include the robust control design on the non linear dynamic model of parallel manipulators.

International Review of Automatic Control (IREACO)

Aims and scope

The **International Review of Automatic Control (IREACO)** is a peer-reviewed journal that publishes original theoretical and applied papers on all aspects of Automatic Control. The topics to be covered include, but are not limited to:

Control of linear/nonlinear systems, Stability, Controllability and Observations, Modeling Estimation and Prediction, Real-Time Systems control, Real-Time and Fault-Tolerant Systems, Multidimensional Systems control, Large Scale Control Systems, Robust Control, Intelligent Control Systems; Stochastic Control, Fuzzy Control Systems, Neuro-Controllers, Neuro-Fuzzy Controllers, Genetic Algorithms, Adaptive Control Techniques;

Control methods, modelling and identification of processes in the fields of industry, ecology, natural resources, including physical, biological and organizational systems; the coverage includes but are not limited to: Power System Control, Automatic Control of Chemical Processes, Automotive Control Systems, Thermal System Control, Robot and Manipulator Control, Process Control, Aerospace Control Systems, Motion and Navigation Control, Traffic and Transport Control, Defense and Military Systems Control, Studies on nuclear systems control, Control analysis of Social and Human Systems, Biomedical control systems.

Instructions for submitting a paper

Contributions may consist of invited tutorials or critical reviews; original scientific research papers (regular paper); letters to the Editor and research notes which should also be original presenting proposals for a new research, reporting on research in progress or discussing the latest scientific results in advanced fields.

All papers will be subjected to a fast editorial process.

Any paper will be published within two months from the submitted date, if it has been accepted.

Papers must be correctly formatted, in order to be published.

Formatting instructions can be found in the last pages of the Review.

An **Author guidelines** template file can be found at the following web address:

www.praiseworthyprize.com/Template_of_IREACO.doc

Manuscripts should be sent via e-mail as attachment in .doc and .pdf formats to:

editorialstaff@praiseworthyprize.com or **santolo@unina.it** (Managing Editor)

The regular paper page length limit is defined at **15** formatted Review pages, including illustrations, references and author(s) biographies.

Pages 16 and above are charged 10 euros per page and payment is a prerequisite for publication.

Subscription rates:

on Cd-Rom, per year:

Institutional: 350* (euros)

Individual: 350* (euros)

Individual Article: 30 (euros)

Print copy, per year:

350** (euros)

350** (euros)

40** (euros)

* To be downloaded

** Shipment costs to be charged

Abstracting and Indexing Information:

Academic Search Complete (EBSCO Information Services)

Cambridge Scientific Abstracts (CSA/CIG)

Elsevier Bibliographic Database SCOPUS

Index Copernicus (Journal Master List)

(continued from outside front cover)

- Nonlinear Observer and Backstepping Control of Quadrotor Unmanned Aerial Vehicle** 631
by M. A. Larbi, K. Zemalache Meguenni, Y. Meddabi, M. Litim
- Regional Gradient Controllability of Semi-Linear Parabolic Systems** 641
by S. A. Ould Beinane, A. Kamal, A. Boutoulout
- A Graphical Approach to Design Digital PI Controller for Integrator Plus Dead-Time Processes** 654
by Ehsan Ghorbani, Alireza Sedaghati
- An Overview of Impact of Nonlinear Friction in Oscillating Control Loops:
from Diagnosis to Compensation** 666
by M. A. Daneshwar, Norlaïli Mohd Nob



Praise Worthy Prize



1974-6059(201309)6:5;1-J